



HIGH VOLTAGE[®]
VLF HIPOT INSTRUMENTS

**PRODUCT
CATALOG**

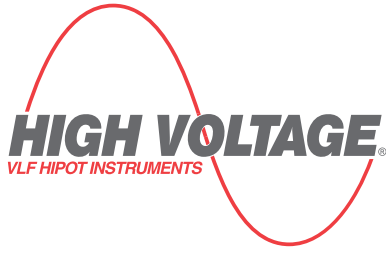
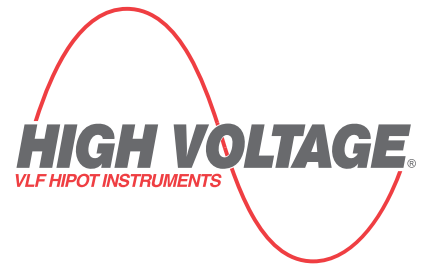

TABLE OF CONTENTS

History of High Voltage, Inc.	3
High Voltage, Inc. Product Summary.....	4
VLF AC Hipots	5-12
HVI “E” Series Product Summary	13
VLF-34E	14- 15
VLF-65E	16
Tan Delta - TD-34E & TD 65E.....	17-19
MV-HV Cable Testing – VLF Technology.....	20-21
CDS Series: Cable Fault Locators, Thumpers, Surge Generators.....	22-28
Portable AC Hipot Test Sets	29-30
PFT - 302CE	31
FPA-12/066F	32-33
AC Dielectric Test Sets	34-37
HPA Series AC Test Set Controllers	38
Aerial Lift & Bucket Truck Tester - ALT-120	39-40
DC Hipot Megohmmeter Combination Units	41-42
DC Hipot Megohmmeter - PTS-300(F)	43
Oil Dielectric Testers - DTS	44-45
Automatic Oil Dielectric DTS-60A.....	46
DVR-150 & DVR-300.....	47
Ω-CHECK™ Tester.....	48-51

For further information and to see our complete product line, please visit www.hvinc.com

We are a worldwide company with representatives in over 100 countries



HISTORY OF HVI

HIGH VOLTAGE, INC. designs and manufactures high voltage test equipment for testing utility substation apparatus, aerial lifts, MV & HV power cable, and cable fault locating products. While HVI is the leader in producing portable field test equipment, we also offer a line of higher power AC and DC high voltage test sets for the industrial market. We are a worldwide company with representatives in over 100 countries and more than half of our sales are foreign.

High Voltage, Inc. was started in 1997 by Stanley G. Peschel, who also founded Hipotronics in 1962 and later sold to Hubbell in 1992. Prior to Hipotronics, Stan worked for his father's high voltage equipment company, Peschel Instruments, starting in the late '50s. Stan was perhaps the leading high voltage design engineer in the world and pioneered much of the HV test equipment and methods now used, including AC Series Resonant technology. He held nearly 20 patents and built Hipotronics into the world's leading HV test equipment producer, prior to its sale. Stan passed away in 2002. Steve and Mike Peschel, President and Chairman respectively, continue this tradition as the third generation of Peschels in the high voltage business, joined by Jim Grayson, VP Operations, and Jonathan Warren in Engineering, all part of the founding group.

HVI was started with a lofty goal: to design and produce the best high voltage test equipment in the world. Starting with decades of design and manufacturing knowledge and experience, ample money for funding research, and years of development time, Stan and his team of engineers and manufacturing people succeeded in producing the next generation of high voltage test equipment. Nearly all of the products produced by HVI are superior to any similar products found elsewhere; the reason why HVI is the leading supplier of high voltage utility field test equipment worldwide, with more than half our business occurring outside the U.S. HVI now produces approximately 1300 instruments a year for the worldwide utility and industrial industry.

One of our greatest design accomplishments was the Very Low Frequency (VLF) technology developed and patented by HVI. HVI produces the top line of VLF AC Hipots, with models ranging from 28kV – 200kV and models designed for short run 15kV cable testing to 138kV cable and a voltage source for Tan Delta and Partial Discharge testing cables rated up to 230kV. HVI is *the* VLF company in this country and around the world, with over 2000 units already delivered to nearly 100 countries.

We at HVI are committed to delivering the best test equipment possible and just as important, the absolute best after sales and customer service support in the industry. There is no better alternative than High Voltage, Inc.



HIGH VOLTAGE PRODUCT SUMMARY

VLF HIPOUT INSTRUMENTS

DC Hipot/Megohmmeter Test Sets

Two Testers in One

80 kVdc
10 mA

100 kVdc
10 mA

600 kVDC @ 5mA

** Top DC
Bucket Truck Tester

AC Hipots - Field Portable

30 kVac @ 1 kVA

50 kVac @ 3 kVA
Cable Output **
Only 1 piece

100 kVac @ 3 kVA

Built for Field Use
Portable
Affordable
Rugged & Reliable
Easily Serviceable

Aerial Lift Test Sets - AC

0 - 60/120 kVac
7 kVA capacitive
4 kVA resistive
Long duty cycle

300 kVac
7 kVA

Bucket Truck Tester
** Top AC
Great for other
AC applications

Very Low Frequency AC Technology

VLF Testing of Cables & Motors/Generators from 0.1 Hz - 0.01 Hz up to 200 kVac

VLF Withstand - VLF-TD - VLF-PD

VLF

200 kVac peak - sine wave
0.1 - 0.02 Hz to 3.75 uF

90 kVac peak - sine wave
0.1 - 0.02 Hz to 2.75 uF

28 kVac
0.4 uF

62 kVac peak - sine wave
0.1 - 0.01 Hz to 5.5 uF
Wind Farm Model

** New Solid State Design
34 kV peak - sine wave
0.1 - 0.01 Hz to 7 uF

TD-34E
0-34 kV

VLF - TD
* Pair *

VLF Diagnostic Cable Testing

Tan Delta & Partial Discharge

TDB-60 0 - 60 kVac

TD/PD Meas.
40 - 200 kV

Oil Dielectric Testing

Standard & Micro Controlled

60 kVac & 100 kVac models

60 kVac
.5/2/3 kV/sec
Digital Display

60 kVac
Fully Programmable
Panel Printer

Concentric Neutral Resistance Tester

Ω-CHECK™

HV Dividers

150 kV AC/DC
300 kV AC/DC

50/60 Hz AC Dielectric Test Equipment: 5 kVA - 50 kVA

AC Testing of High Capacitance Loads - up to 300 kVac

5 kVac @ 1A Motor Testing

10 kVac @ 10 kVA
Low PD < 10 pc

100 kVac
10 kVA
PD < 10 pc

Capacitor Discharge Systems - Thumpers

Three Full Joule Outputs - VLF/Thumper Combo

** VLF - Thumper

0-9/18/36 kV
3200J 400mA

Models for URD &
Network Systems

TDR/Radar

* Van Package *

Very Low Frequency AC Technology – VLF

**Cable & Motor/Generator
High Voltage Withstand
& Diagnostic Testing**

High Voltage, Inc.
Copake, NY USA
VLF leader since 1997



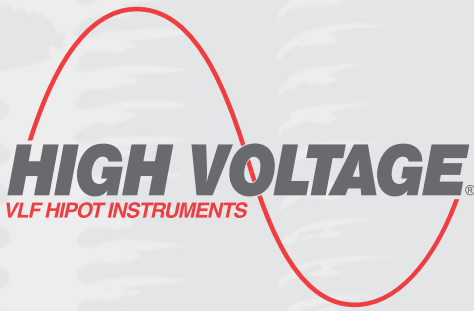

HVI – The World's VLF Source Made in the USA

90 countries served since 1998

- **Greatest Model Selection**
- **Highest Voltages Available**
- **Highest Power Ratings Delivered**
- **Only VLF Thumper Produced**
- **Rugged oil filled non-electronic design offers extreme reliability and ease of field service if ever necessary**
- **Latest solid state, computer controlled wireless designs offered**

HVI offers more models and higher voltage models than any other vendor in the world. Models range from 30 kVac – 200 kVac peak, offering from 0.4 μ F to 50 μ F of load capability. Load ratings shown below are at the lowest frequency.

Original Patented Transformer Based Design

VLF-30CM	0-30 kVac, 0.1 Hz, load rated to 0.4 μ F
VLF-4022CM	0-44 kVac, 0.1 Hz - 0.02 Hz, load rated to 5.5 μ F
VLF-50CM	0-50 kVac, 0.1 Hz - 0.01 Hz, load rated to 50 μ F
VLF-6022CM	0-62 kVac, 0.1 Hz - 0.02 Hz, load rated to 5.5 μ F
VLF-65CMF	0-65 kVac, 0.1 Hz - 0.01 Hz, load rated to 22 μ F
VLF-90CMF	0-90 kVac, 0.1 Hz - 0.02 Hz, load rated to 2.75 μ F
VLF-12011CMF	0-120 kVac, 0.1 Hz - 0.01 Hz, load rated to 5.5 μ F
VLF-200CMF	0-200 kVac, 0.1 Hz - 0.02 Hz, load rated to 3.75 μ F
VT33	VLF: 0 - 33 kVac, 1.0 μ F @ 0.1 Hz Thumper: 0 - 13 kVdc @ 760 Joules

Solid State Computer Controlled Models

VLF-34E	0-34 kVac, 0.1 Hz - 0.01 Hz, load rated to 5.0 μ F
VLF-65E	0-65 kVac, 0.1 Hz - 0.01 Hz load rated to 5.0 μ F

The HVI VLF technology is protected
under U.S. Patent # 6,169,406

Very Low Frequency AC Testers

AC testing of Cables, Motors & Generators is now easier than ever.

Since the introduction of the High Voltage, Inc. line of portable and affordable VLF hipots, there is a practical method of AC field testing highly capacitive loads, particularly cables and rotating machinery. High Voltage, Inc. offers a full line of VLF AC Hipots from 30 kVac to 200 kVac with models that can test up to 50 μ F of load, cables over 50 miles in length and the largest of generators or motors. Use VLF for **AC Withstand** stress tests and/or as a voltage source for **Tan Delta** and **Partial Discharge Diagnostic Testing**. HVI offers both its original, patented long proven oil filled power supply models with analog controls and its all new solid state, computer-micro controlled wireless design. Both have diagnostic accessories available.

SINCE 1998, HVI has produced the most economical, rugged, and reliable VLF products available. Our electro-mechanical control and our oil filled HV power supply designs are **extremely dependable**, and if necessary, more easily field serviced than the electronic designs. **The HVI design has a proven record with well over 2000 units in service worldwide.** The HVI VLF design offers the best of everything, with manual, easy to use controls but also sophisticated data collection. Electric utilities and industrials have long recognized the benefit of our technology. HVI knows how to build long lasting field test equipment. HVI now also offers the latest in solid state design VLF units that offer many benefits, like automatic programmable control and wireless communications.

All HVI VLF designs produce a **sine wave output** that meets the requirements of world standards, permitting it to be used as a voltage source for **Tan Delta** and **Partial Discharge** diagnostic testing. A sine wave producing VLF is required to perform these tests. Keep all options open by choosing a sine wave design, like the HVI VLF.

Why Buy HVI VLF Products?

- **HVI Design - Portable, Affordable, Rugged, Reliable, & Long Proven**
- **HVI Support & Service – Best Customer Support, Ship from Stock, Instant Factory Help Quick Service Turn Around, Repair & Cal. Locations Worldwide, Reps in over 90 countries**

What is VLF?

VLF stands for Very Low Frequency. A VLF hipot is an AC output high voltage instrument. HVI VLF products provide sinusoidal AC voltage but at 0.1 Hz - 0.01 Hz, compared to the 50/60 Hz output of conventional AC test sets. It is still an AC voltage with sinusoidal polarity reversals every half cycle. The VLF instrument is used to provide a simple go/no-go, or pass/fail, withstand test. Also, VLF instruments can be used as the voltage source for performing off-line **Partial Discharge** and **Tan Delta** cable diagnostic testing, both from HVI.

Why VLF?

VLF test sets are used to field test high capacitance loads like cables and motors/generators. The lower the frequency of an AC source, the lower the current and power required to apply a voltage to a capacitive load like a cable. At 0.1Hz, it requires 600 times less power to test a cable than at 60 Hz. The HVI VLF instruments permit users to field test long cables and large generators with a portable and affordable test set. A 100 lb VLF instrument can do the job of a multi-ton 60Hz AC test set. Cables should be tested with AC voltage. With the HVI VLF products, it can be done with a practical, economical, and easy to use package.

When and Where Is VLF Used – Cable & Rotating Machinery

The principal use of VLF is testing medium and high voltage shielded power cables. A long cable may have many microfarads of capacitance. To AC high voltage test this cable requires the use of VLF technology. An AC voltage test is the best way to verify the AC integrity of a cable. If a cable can't hold 2 – 3 times normal voltage, it is not healthy and an in-service failure is likely. Use the VLF to cause defects to fail during the test. Find the fault, make the repair or replacement, and be left with a better cable. It is especially valuable for **verifying a cable after installation or repair**: far better than using a DC hipot, 5kV megohmmeter, hot stick adaptor, or soak test, none of which provide meaningful information about a cables ability to

PEAK
KILOVOLTS

withstand several times normal AC voltage. IEEE 400, 400.2, & 433, VDE 0276, CENELEC HD 620/621, SANA 10198, NEN 3620 and IEC 60502-2 standards all define VLF testing.

VLF is also very useful for testing **large rotating machinery**, since it provides a portable and affordable method of field testing coils and is sanctioned by the IEEE 433-2009 standard.

Partial Discharge & Tan Delta VLF Cable Diagnostic Testing

The VLF hipot alone provides a withstand, or proof test. It can also be used as the voltage source for off-line **Partial Discharge** and **Tan Delta** cable diagnostic testing. HVI can serve the needs of the industry for cable and generator testing better than any other. Contact HVI for additional information on other cable testing methods and products available.

For more information on VLF testing, visit www.hvinc.com

Benefits of HVI VLF AC Hipots

- *Portable and affordable*
- *All models feature a true sinewave output*
- *Waveform is independent of load capacitance between 0.01 μ F and maximum load*
- *Highest load ratings available*
- *Highest voltage models available*
- *Simple and easy operation*
- *AC testing does not degrade good cable insulation*
- *Harmful space charges are not injected into the cable insulation*
- *No traveling waves are generated*
- *BNC scope output for waveform viewing*
- *Rugged and reliable design less prone to failure from transients*

Two Design Choices

Patented original, electro-mechanical, transformer designs and the latest solid state computer controlled designs available from HVI.

VLF-30CM(F) Best for testing 5 kV - 15 kV cables

Our smallest VLF model, the VLF-30CM approaches the size and cost of a DC hipot and is designed for quick & easy short-run cable testing. It can test up to 0.4 μF of load, about 4000 feet (1200 m) of a typical 15 kV class cable. Small, light, inexpensive, and easy to use. Now there's no reason not to use VLF.

Quick & Simple
15 kV cable testing
Low Cost
Easy to Use
Small & Light



Input: 120 volts, 60 Hz, 5 A peak, 2.5 A average
or 230 volts, 50/60 Hz, 3 A peak, 2A average (F suffix)

Output: 0 – 30 kVac peak, 0.1 Hz, sinusoidal

Duty: Continuous

Load Rating: 0.4 μF

Metering: Voltmeter: -30 kVac – 0 – +30 kVac
Charging Current meter: 0 – 50 mA peak

HV Cable Output: Shielded EPR output cable - 20 ft. (6 m)

Size & Weight: 15" w x 11.5" d x 22" h, 82 lbs. (88 lbs. - F version)
381 mm w x 292 mm d x 559 mm h, 39 kg
(42 kg - F version)

VLF-4022CM(F) Two piece portability for field testing 25 kV & 35 kV cables

This model, with its 44 kVac peak output, is suitable for all testing of 25 kV cable and Maintenance testing on 35 kV cable. Its high load capacity enables it to test up to approximately 10 miles of cable (at .02 Hz), depending on type. This model includes a charging current and load capacitance meter, and a center zero peak kilovolt output meter.



Two-piece easy portability
(see page 7)



Input: 120 volts, 60 Hz, 10 A peak, 5 A average
or 230 volts, 50/60 Hz, 6 A peak, 2.5 A average (F suffix)

Output: 0 – 44 kVac peak, 0.1/0.05/0.02 Hz sinusoidal

Duty: Continuous

Load Rating: 1.1 μF @ 0.1 Hz, 2.2 μF @ 0.05 Hz, & 5.5 μF @ 0.02 Hz

Metering: Voltmeter: Center Zero -45 – 0 – +45 kVac peak
Charging Current meter: 0 – 100 mA peak
Load capacitance meter: 0 – 6 Microfarads

Cable Lengths: Shielded RG/8U output cable - 20 ft. (6 m)
Interconnect cable - 10 ft. (3 m)

Size & Weight: Controls: 22" w x 11.25" d x 15.25" h, 50 lbs.
559 mm w x 286 mm d x 387 mm h, 23 kg
HV Tank: 14.5" w x 10.5" d x 19" h, 72 lbs.
368 mm w x 267 mm d x 483 mm h, 33 kg

VLF-6022CM(F) Two piece portability for testing up to 35 kV cable systems - Wind Farms

This model, with its 62 kVac peak output, is suitable for testing cables rated up to 35 kV. Its high load capacity enables it to test up to approximately 10 miles of cable (at .02 Hz), depending on type. This model includes an enhanced features package: a charging current and load capacitance meter, test dwell timer, and polarity indicating lights.



**Network Systems &
Wind Farm Model**

Two-piece easy portability



Input: 120 volts, 60 Hz, 15 A peak, 7.5 A average
or 230 volts, 50/60 Hz, 8 A peak, 4 A average (F suffix)

Output: 0-62 kVac peak, 0.1 Hz - 0.02 Hz

Duty: Continuous

Load Rating: 1.1 μF @ 0.1 Hz, 2.2 μF @ 0.05 Hz, & 5.5 μF @ 0.02 Hz

Metering: Voltmeter: 0 – 65 kVac peak
Charging Current meter: 0 – 100 mA peak
Load capacitance meter: 0 – 6 Microfarads
Settable test duration timer

Cable Lengths: Shielded EPR output cable - 20 ft. (6 m)
Interconnect cable - 10 ft. (3 m)

Size & Weight: Controls: 26" w x 13" d x 16" h, 75 lbs.
660 mm w x 330 mm d x 406 mm h, 34 kg
HV Tank: 15" w x 10.25" d x 21.5" h, 120 lbs.
381 mm w x 260 mm d x 546 mm h, 54 kg

All HVI VLF models are labeled and metered for peak voltage, not rms. When testing, use the peak voltage values given in your specification.



One piece with casters, truck mounting blocks, skid, or separate components.



200 kVac

The Testing Service & Electrical Contractor Model

VLF Thumper

VLF: 33 kV @ 0.1 Hz @ 1 μ F
 Thumper: 13 kV @ 760 joules
 Burner: Alt. polarity discharge
 TDR/Radar: Ready to go.



VLF-12011CMF 69 kV Cable Withstand & 115 kV Cable Diagnostics

The **VLF-12011CMF** provides a 120kVac peak output voltage, suitable for VLF hipot testing 69 kV cable and as a voltage source for partial discharge and tan delta testing of 115 kV cable. In addition to the standard controls described, this model also contains a Cable Burn mode. Cable reels provide 100' (30m) of HV and ground cable.

Input: 230 volts, 50/60 Hz, 30 A peak, 25 A average
Output: 0 – 120 kVac peak, 0.1/0.05/0.02/0.01 Hz sinusoidal
Duty: Continuous
Load Rating: .55 μ F @ 0.1 Hz, 1.1 μ F @ 0.05 Hz
 2.75 μ F @ 0.02 Hz, 5.5 μ F @ 0.01 Hz
Metering: Voltmeter: 0 – 120 kVac peak
 Charging Current Meter: 0 – 100 mA peak
 Load capacitance meter: 0 – 6 microfarads
 User programmable test duration timer

Cable Lengths: Shielded EPR output cable 100 ft. (30m)
 Ground cable 100 ft. (30m)

Sizes & Weight: Controls: 17" w x 11" d x 9.5" h, 20 lbs.
 432 mm w x 280 mm d x 241 mm h, 9 kg
 Regulator: 20" w x 14" d x 27" h, 160 lbs.
 508 mm w x 356 mm d x 686 mm h, 73 kg
 HV Tank: 26" w x 20" d x 22" h, 390 lbs.
 660 mm w x 508 mm d x 559 mm h, 177 kg
 Overall: 30" w x 60" d x 51" h, 853 lbs.
 762 mm w x 1524 mm d x 1295 mm h, 388 kg



VLF-200CMF Highest voltage rating available

The **VLF-200CMF** provides a 200 kVac peak output voltage, suitable for performing VLF hipot tests on 138 kV cable and as a voltage source for tan delta and partial discharge testing on 230 kV cable. The controls offer all the features of our other VLF models along with VLF Cable Burning. Trailer mount optional.

Input: 230 V Single phase, 80 A peak, 50/60Hz
Output: 0 – 200 kVac peak, 100 mA. Bushing output – no cable provided
Load: .75 μ F @ 0.1 Hz, 1.5 μ F @ 0.05 Hz, 3.75 μ F @ 0.02 Hz
Duty: Continuous
Metering: Voltage: 0 – 200 kVac peak 3.5" analog display
 Current: 0 – 200 mAac 3.5" analog display
Controls: HV On/Off, Motorized Voltage Control, Zero Start Interlock, External Interlock, Digital Dwell Timer, Capacitance Measuring Circuit, Cable Burn Mode, Fixed 120% Overload, Automatic Data Logger

Size/Weight: Controls: 24" w x 25.5" d x 71" h, 650 lbs.
 610 mm h x 648 mm w x 1803 mm h, 295 kg
 HV Tank: 59" w x 37" d x 87" h, 3700 lbs
 1499 cm w x 2362 mm d x 2210 mm h, 1678 kg



VT33(F) VLF & Fault Locator Combo 2 tools in 1 box

The **VT33** is the worlds only combination VLF hipot and cable fault locator, or thumper. It is the complete tool for AC testing and fault locating cables rated up to 25kV. It offers a 33 kVac peak VLF output, VLF Cable Burn mode, and a 760 joule discharge output. It is fully TDR/radar ready.

Input: VT33: 120 V, 60 Hz, 10 A
 VT33F: 230 V, 50/60 Hz, 5 A
VLF Hipot Output: 0 – 33 kVac peak @ 0.1 Hz
Load Capability: 1 μ F – more than 1 mile (1.6 km) of 15 kV & 25 kV cable
Discharge Output: 0 – 13 kVdc @ 760 joules
Discharge Rate: Every 8 seconds
VLF Burner: Arcs cable every few seconds using cable energy to burn.
TDR Interface: Arc Reflection & Current Impulse
Size & Weight: 28" w x 26" d x 44" h, 245 lbs.
 711 mm w x 660 mm d x 1118 mm h, 111 kg
Cable Outputs: 50' (15 m) shielded HV cable & ground

The "E" Series VLF Models Solid State Design - Fully Automated w/PC App - Wireless

The "E" Series of VLF products offer the latest in electronic design, with fully automated and programmable operation, data collection and reporting, and Tan Delta ready, all wirelessly controlled via custom software. There is no better VLF available. The two models shown below each have an optional **HVI designed Tan Delta** measurement accessory and **Partial Discharge** detection options are available from HVI and from others.

VLF-34E



"E" Series Front Panel



VLF-65E



0 – 34 kVac peak, Sinusoidal
0.5 μF – 5.0 μF, 0.1 Hz – 0.01 Hz

Refer to the separate VLF-34E & VLF-65E brochures for details

0 – 65 kVac peak, Sinusoidal
0.5 μF – 5.0 μF, 0.1 Hz – 0.01 Hz

Typical Front Panel Controls Electro-Mechanical Designed Models



Data Logger Option



Plug into VLF panel
Wireless to laptop
With reporting software



HVI Founder & Inventor
Stanley G. Peschel (1930 – 2002)



Holding the first portable & affordable
VLF – 1998. A 40 kVac model.
A breakthrough in VLF technology.

Cable Diagnostic Testing Accessories for all HVI VLF Models

HVI offers the accessories used for performing VLF Tan Delta and VLF Partial Discharge diagnostic testing for cables and rotating machinery. Some of the models offered are designed and produced by HVI and some are from other vendors, designed to function with the HVI VLF products. Other vendors also offer these accessories that may be used with the HVI VLF designs. **Models are available up to 200 kV peak.** Consult HVI for more details and refer to separate literature for each item.

Tangent Delta (δ) or Loss Angle Measurement



TD-34E
34 kVac peak



TD-65E
65 kVac peak



TDB-60
60 kVac peak
(since 1999)

**Partial Discharge Detection and Location
& Tan Delta Measurement**



Shown is PDIX-70, 70 kV peak
models to 200 kV available

Application Help and Field Test Scenes

Selecting a VLF Model

Considerations when selecting the right model: voltage, μF rating, μF rating at 0.1Hz, & control features.

Voltage: What is the cable voltage rating and what tests will be performed? Table from IEEE 400.2-2013.

Cable Rating	Installation	Acceptance	Maintenance
phase to phase	phase to ground	phase to ground	phase to ground
kVrms	kVrms (kVpk)	kVrms (kVpk)	kVrms (kVpk)
5	9 (13)	10 (14)	7 (10)
8	11 (16)	13 (18)	10 (14)
15	19 (27)	21 (30)	16 (22)
25	29 (41)	32 (45)	24 (34)
35	39 (55)	44 (62)	33 (47)
46	51 (72)	57 (81)	43 (61)
69	75 (106)	84 (119)	63 (89)

Wind Farm 35kV Cables are Ideal for VLF Withstand Testing



VLF Acceptance Test per IEEE 400.2-2013
All 3 phases @ 62 kVac for 60 minutes

Cable system is newly installed needing a VLF Withstand to find defects and faulty workmanship. Find the bad spots.



200 kV VLF van in service, high voltage out thru top.



μF Rating: VLF hipots are rated by the capacitance of the loads they can test. To select the right model, either the load capacitance must be known or the cable length if the $\mu\text{F}/\text{km}$, $\mu\text{F}/\text{ft}$, etc. is known.

μF Rating at 0.1 Hz: If the VLF is to be used as a voltage source for performing Tan Delta and Partial Discharge testing, the load rating at 0.1 Hz is important, as this is the frequency most used for these tests. In some cases, 0.05 Hz frequency can be used. If the VLF is to be used for hipotting, then any frequency can be used.

Control Features: Are the automated, laptop controlled, etc. features of the "E" Series necessary or are the basic manual controls of our original design adequate, saving money and gaining other benefits?



Comment: A fifth consideration could be the vendor? Where it is made and serviced, how available is it, how quick is the service turnaround, and what is the vendors reputation. All HVI products are **Made in the USA** and most are in stock.



VLF Options Available



Hand Truck Option for some models



Cable Reels

HV output cable attachments



Other Cable Test & Fault Locating Products

VLF Cable Testing & Fault Locating Van Ready Custom Packages

Instant & easy test van: HVI can mix and match products to deliver a custom made module to handle all your test and fault locating needs. Just drop it in your truck.



Can Include

- VLF Hipot
- Tan Delta
- Data Logger
- Thumper
- TDR/Radar
- UG Fault Finder
- Cable Reels
- DC Hipot
- and more

fault location

TDR/Radar display

Ω -CHECK® Concentric Neutral Resistance Tester & Substation Ground Cable Integrity Check



How good are your neutrals?

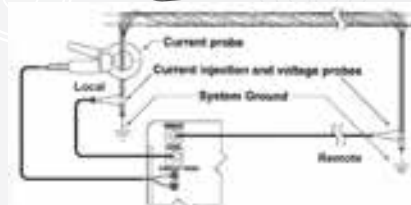

All HVI Products are **Made in the USA**

www.hvinc.com

VLF & TD - New from High Voltage, Inc.

The HVI "E" Series Newly designed solid state, wirelessly controlled VLF with matching Tan Delta transducers & custom PC application software.



Everything you need is here!

- Fully Automatic & Programmable
- VLF & TD Wirelessly Controlled
- Custom PC Application Software
- Remotely or Locally Controllable
- USB Data Storage for Mobile Data
- Extensive Data Logging & Reporting
- And other "E" Series advantages



Tan Delta TD-34E
34 kVac for use with the VLF "E" Series



Model VLF-34E
0 – 34 kVac peak
0.5 μ F – 5.0 μ F
0.1 Hz – 0.01 Hz



VLF AC Withstand, Tan Delta, & Monitored Withstand Testing
Test data stored in VLF memory, on USB drive, and in laptop

Model TD-65E
65 kVac for use with the VLF "E" Series



Model VLF-65E
0 – 65 kVac peak
1.0 μ F – 10.0 μ F
0.1 Hz – 0.01 Hz

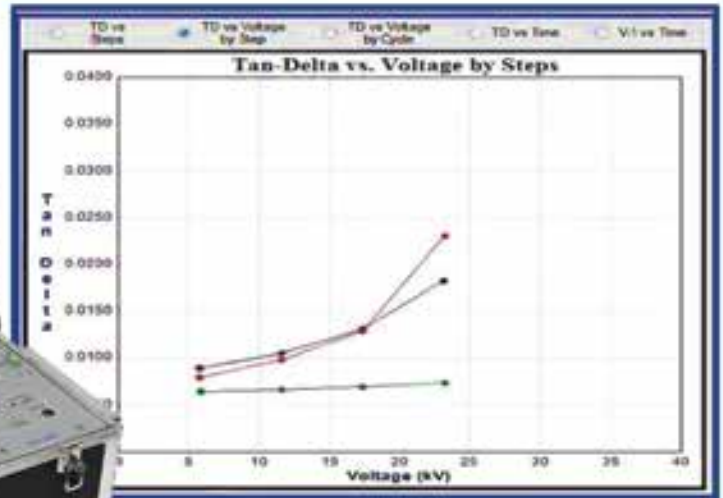

 **HIGH VOLTAGE, INC.** - The World's Source for High Voltage Test Equipment
Three Generations of Experience. All HVI Products are **MADE IN THE USA.**

HIGH VOLTAGE, INC. 31 County Rt. 7A • Copake, NY 12516 • (518) 329-3275 • Fax: (518) 329-3271
sales@hvinc.com • www.hvinc.com

High Voltage, Inc. designs and manufactures high voltage test equipment for utility and industrial applications, including Very Low Frequency (VLF) AC hipots, Cable Diagnostic testers, Cable Fault locators, DC & AC hipots, HV Dividers, Concentric Neutral, Oil Dielectric, & Aerial Lift testers, and more.

VLF-34E 34 kV VLF Tester

Very Low Frequency AC Technology

VLF & DC Output • Sheath Testing • Cable Burning

The VLF-34E is a new generation VLF AC hipot that uses a solid state design with microprocessor controls. It meets the requirements of applicable world standards regarding cable testing up to 25kV class Maintenance testing. It is light, compact, rugged, and very portable. Its sine wave output is suitable for using optional external PD and TD detection equipment. Using a **TD** and **PD option**, the VLF-34E is all that is needed for nearly all cable testing up to 25kV class.

Specifications – Solid State Design

Input Voltage:	90 Vac – 265 Vac, 50 Hz/60Hz, 5A max.
HV Output:	0-34 kVac peak/0-24 kVac rms - Sinusoidal DC: +/- 34 kV Square wave: 34 kV Sheath Tester
Duty:	Continuous
Frequency:	0.1 Hz to 0.01 Hz
Load Rating:	0.5 μ F @ 0.1 Hz @ 34 kV 1.0 μ F @ 0.05 Hz @ 34 kV 5.0 μ F @ 0.01 Hz @ 34 kV μ F rating increases at lower voltages Ex: 0.77 μ F @ 0.1 Hz @ 22 kV peak
Metering:	Voltage kV peak or RMS Current mA peak or RMS
Calculated:	Capacitance, Resistance, Flashover voltage, Time to Failure
Size/Weight:	19.7" x 12.0" x 18", 45 lbs. 500mm x 305mm 458mm, 21 kg.
Case:	Hard "Pelican" type case with extendable handle and wheels
Lead Outputs:	HV lead: 20' RG8/U, Ground 20' #2
Fault:	Smart Fault Management or shutdown on Fault
Reports:	Test Records stored in non-volatile memory or via USB memory stick
PC Interface:	USB, XBee® wireless, RS-232/422
PC Software:	Remote Control & Test Reports

Optional Tan Delta and Partial Discharge diagnostic equipment available.

ISO 9001:2008



Easy to use controls. Programmable test sequences & manual control, USB port for downloading data and for unlimited test report capture, wireless computer interface to control and download optional Tan Delta diagnostics and for remote control operation

Cable Standards met: IEEE 400.2-2013,
IEEE 400-2001, IEEE 433-2009, IEC 60060-3
VDE DIN 0276-620/621, CENELEC HD 620/621



VLF-34E 34 kV VLF Tester

Very Low Frequency AC Technology

Additional Specifications

Voltage Measurement	Range:	0.1 kV - 34 kV peak/0.1 - 25 kV rms
	Accuracy & Resolution:	1% & 0.1 kV peak
Current Measurement	Range:	0 - 15 mA rms
	Accuracy & Resolution:	1% & 1 μ A
Capacitance Measurement	Resolution:	0.001 μ F
	Accuracy: load current below 50 μ A:	No display
	load current 50 μ A & 0.5 mA:	Greater of 10% or 0.01 μ F
	load current above 0.5 mA:	Greater of 5% or 0.01 μ F
Resistance Measurement	Resolution:	0.1 M Ω
	Accuracy: load current below 50 μ A:	No display
	load current 50 μ A & 0.5 mA:	Greater of 10% or 5 M Ω
	load current above 0.5 mA:	Greater of 5% or 1 M Ω
Temperature Ranges	Operating:	20°F to 120°F, -7°C to 50°C
	Storage:	-10°F to 150°F, -23°C to 66°C
	Humidity	80% up to 90°F, 32°C

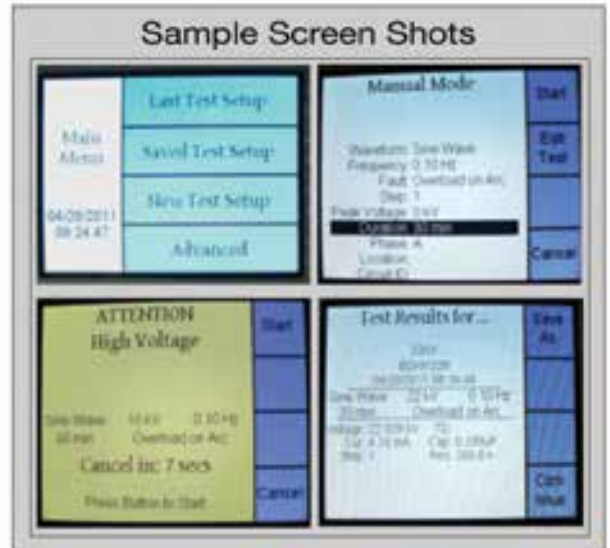

Tangent Delta Measurement & Partial Discharge Detection for all models Models TD-34E & TD-65E: Wireless to VLF & to custom PC Application



VLF Tests Performed

- VLF AC Withstand
- VLF Tan Delta (δ)
- VLF Partial Discharge

All HVI VLF products deliver the above cable tests and others per **IEEE 400.2**. Also use the VLF-34E for testing motors & generators per **IEEE 433**.

Download the brochures for the TD-34E, VLF-65E, TD-65E, and for all VLF models and other products from www.hvinc.com.



Model VLF-65E
0 - 65 kVac pk @ 1.0 μ F @ 0.10 Hz

Ideal for Wind Farms

VLF Withstand
VLF Tan Delta
VLF Partial Discharge

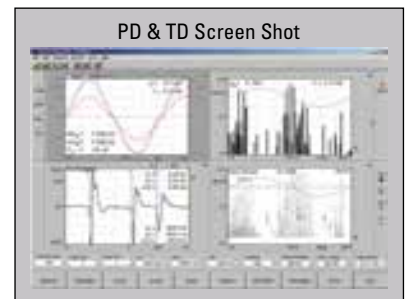
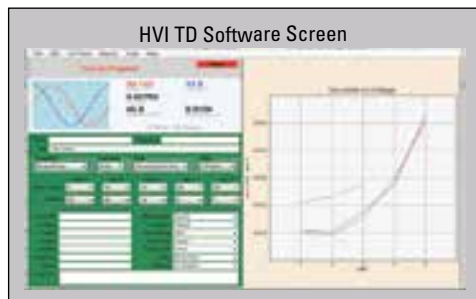

VLF-65E 65 kV VLF Tester

Very Low Frequency AC Technology

The **VLF-65E Test Set** is the latest addition to the new generation of **VLF AC Hipots** from HVI that use a dry-type, air cooled, solid state design with microprocessor control. Its test programming, numerous output functions, wireless communications, and data retrieval are intuitive and easy to learn, as well as its PC Application software. It is portable, affordable, and built for the rigors of field use, like all HVI products. Its **0 - 65 kVac** output voltage meets world standards for Acceptance testing up to 35 kV class cable and its **sine wave output** is suitable for using optional **Tan Delta and Partial Discharge** measurement systems, like the HVI **TD-65E Tan Delta System**. The VLF-65E offers everything needed for fully testing cables rated up to 35 kV. The **HVI VLF-34E and TD-34E** for testing up to 25 kV cables are shown below.

HVI offers the broadest VLF line with 12 models available, with higher power and voltage, electronic and electro-mechanical designs, a VLF/Thumper combo, and Tan Delta, all with superior factory support and field service. HVI produces products for testing substation apparatus, motors/generators, transformers, aerial lifts, cables, and cable fault locating. HVI has delivered its products to over 100 countries and has service locations worldwide. Over 2000 VLF units alone have been delivered to over 80 countries.

VLF & DC OUTPUT | SHEATH TESTING | CABLE BURNING

Specifications & Features

Input:	100 Vac – 265 Vac, 50 Hz/60 Hz, 20A max
Output:	VLF Sinewave: 0 - 65 kVac peak/46 kVac rms @ 26 mA VLF Square wave: 0 - 65 kVac peak @ 45 mA DC: 0 - ± 65 kV @ 45 mA Sheath Test – User Programmable
Duty:	Continuous
Frequency:	0.1 Hz to 0.01 Hz in steps of 0.01 Hz
Load Rating:	1.0 µF @ 0.10 Hz @ 65 kV 2.0 µF @ 0.05 Hz @ 65 kV 5.0 µF @ 0.02 Hz @ 65 kV 10.0 µF @ 0.01 Hz @ 65 kV µF rating increases at lower voltages Ex: 1.4 µF @ 0.1 Hz @ 47 kV peak
Metering:	Voltage kV peak or rms, +/-1% accuracy Current mA peak or rms, +/-1% accuracy
Calculated:	Capacitance, Resistance, Tan Delta, Flashover voltage, Time to Failure
Fault Response:	Smart Fault Management – Fault “Burning” or Shutdown on Fault
Reports/Data:	Up to 50 test records can be stored in non-volatile memory or removable USB memory stick
PC Interface:	USB and XBee wireless
PC Software:	Remote Control & Test Data Reporting
Size/Weight:	22" w x 14 1/2" d x 26" h, 150 lbs 559 mm x 369 mm x 660 mm, 68 kg
Output Leads:	HV: 20'/6m flexible x-ray, Ground #2 - 20'/6m # 10 test leads, ground hook, line cord, etc.



VLF-65E has everything needed: Programmable test sequences, automatic & manual control, USB port for capturing data for export, wireless computer interface for remote control operation and data upload, and onscreen Tan Delta data display with optional TD-65E.

Meets: IEEE 400.2, IEEE 400, IEC 60060-3, CENELEC HD 620/621, VDE DIN 0276-620/621. IEEE 433 for motors/gens.

VLF-34E & Tan Delta TD-34E



VLF: 0-34 kV pk. @ 0.5 uF – 5.0 uF
TD: 0-34 kV pk. Tan Delta Diagnostics

 HVI: The World's VLF Source
All HVI Products are Made in the USA

ISO 9001:2008



TAN DELTA (δ) CABLE TESTING

Model: TD-34E 34 kVac peak @ 0.1 Hz

VLF-TD CABLE DIAGNOSTIC TESTING

How good are my cables? Are they like new or slightly, moderately, or highly degraded?

Tan Delta testing (or Tan δ /Dissipation Factor/Loss Angle) is a non-destructive diagnostic test performed to measure the condition, or level of deterioration, of a cable systems insulation. A population of cables is tested and graded. A comparative analysis is then made to predict relative life expectancy and to help prioritize cable replacement, rejuvenation/injection, or to determine what further tests may be useful, possibly a **VLF Withstand** or **VLF Partial Discharge** test.

Tan Delta testing is a well proven, common method of evaluating the dielectric integrity of insulation. It is an off-line test using a 0.1 Hz VLF AC voltage source. It is a qualitative test long established and defined by the IEEE and other similar organizations. It is easily performed, relatively economical, and provides useful results the operator can interpret and act on.

Why Choose the TD-34E?

The TD-34E, along with the HVI VLF-34E AC hipot, is the latest in design using current electronic technology. Together they permit the user **to perform all VLF and VLF-TD tests possible** and offer the best wireless operation and data collection, aided by the HVI custom application software written solely for the two devices. **There is no better alternative.** HVI has been supplying the world with VLF and Tan Delta technology since 1998, with more models, greater voltage range, and higher power capability, all with the **superior sales and service that HVI is well known for worldwide.**

Tests for MV Cable & Rotating Machinery

VLF Withstand • VLF Tan Delta • VLF Partial Discharge
VLF-TD Monitored Withstand Test
Other TD/PD Diagnostic accessories also available

World Standards Met

IEEE 400, IEEE 400.2, IEEE 433, DIN VDE 0276, CENELEC HD620 S1, NEETRAC CDFI, & others

The HVI VLF Products – Since 1998

VLF Hipots: 28 kVac – 200 kVac, 10 models
0.4 μ F – 50 μ F, 0.1 Hz – 0.01 Hz
Tan Delta: TD-34E & TDB-60
PD/TD Accessories: 40 kVac – 200 kVac available



HVI: The World's VLF Source
All HVI Products are **Made in the USA**

TD-34E Tan Delta Transducer

FEATURES & OPERATIONS		SPECIFICATIONS*
Voltage Measurement	Range	1 - 34 kV peak/1 - 25 kV rms
	Accuracy & Resolution	1% & 0.1 kV peak
Current Measurement	Range	0 - 15 mA rms
	Accuracy & Resolution	1% & 1 μ A
Tan δ Measurements	Load Range	Freq: 0.1 Hz - 0.01 Hz, 5 nF - 10 μ F
	Accuracy & Resolution	1.0 x 10 ⁻⁴ & 1 x 10 ⁻⁵
Communications	Range ~ 30 m	XBee 802.15.4 (not Bluetooth)
Power Input - Battery	Alkaline	Two "C" cells required – 4 provided
	NiMH	Rechargeable batteries acceptable – not included
Dimensions	TD Transducer	8" x 4.5" x 4" (203 x 114 x 102 mm)
	TD Carrying Case	12" x 11" x 7.5" (305 x 280 x 191 mm)
	Accessories Bag w/cables, tripod, . .	15" x 5" x 12" (381 x 127 x 305 mm)
Weight	TD Transducer - w/case	5 lbs/2.3 kg 8 lbs/3.6 kg
	Access. bag	10 lbs/4.5 kg
Input Cable Connection		MC Connector - Male 120 square mm
Output Connection		1/4 - 20 female thread w/accessories
Ground Connection		1/4 - 20 stud w/wingnut
Environmental Requirements		Operating temp: - 10°C to + 55°C Storage temp: - 25°C to + 65°C Humidity: 80% up to 31°C (88°F)

*Specifications are subject to change without notice in the interest of continuous product improvement.



For 5 – 25 kV cable: VLF-34E & TD-34E

TD-34E TAN δ CABLE TESTER

The following accessories are shipped with the TD-34E Tan Delta product from HVI. The TD-34E is provided in its own Pelican case for maximum protection, along with its two USB devices and batteries. The remainder of the accessories are provided in a black canvas bag as shown.

Pelican Case for TD-34E & Several Accessories

- TD-34E Tan Delta Measurement Device (1)
- C-size Alkaline batteries (4) only 2 needed
- Xstick USB to XBee Network adapter (1)
- 4GB USB flash drive w/PC application software and firmware update (1)
- 12" w x 11" d x 7.5" h (305 w x 300 d x 191 h mm)

Canvas Bag for TD-34E Accessories

- Operators Manual
- HV shielded output cable w/male MC connector, connects from TD-34E to VLF-34E. 20'/6m (1)
- 18 AWG unshielded silicone cable w/banana jack & battery clamp, connects from TD to load. 10'/3m (1)
- Ground cable, 10 AWG w/battery clamp. 10'/3m (1)
- 1½" Aluminum ball w/¼ x 20 threaded thru hole (1)
- ¼" x 1" threaded brass rod for TD-34E output (1)
- Corona suppression spinning: 2" x 5" (1)
- Tripod Stand: 13" – 65" h, 330 – 1651 mm h (1)
- 15" w x 5" d x 12" h (382 w x 127 d x 305 h mm)



The HVI TD-34E connected to the VLF-34E provides the best combination for VLF & TD testing of power cables, offering all the features needed for complete, automatically generated test routines, data collection, Wi-Fi data export capabilities, and detailed report generation. **HVI – Still the VLF Source**

VLF Tan Delta (δ) Cable Testing

Model TD-65E | 65 kVac peak @ 0.1 Hz

The latest in TD & VLF technology: only from HVI



HVI – The World’s Source for VLF Technology **Made in the USA!**

How good is my cable? Like new, slightly, moderately, or highly degraded?

Tangent Delta, or Dissipation Factor, or Loss Angle testing is a method of determining the degree of deterioration within a cables insulation. Is it perfect, nearly a pure capacitor or it is degraded, containing resistive elements: now an RC circuit - not only C?

Using Tan Delta testing to learn the condition of your cables’ insulation helps one make a comparative analysis of many cables to prioritize cable replacement, cable injection, and/or to determine what additional tests may be useful, like a **VLF Withstand** or **VLF Partial Discharge** test.

Tan Delta cable testing is a well proven, common method of evaluating the dielectric integrity of insulation. It is similar to 50/60 Hz. Power Factor testing only **it uses an off-line 0.1 Hz VLF AC voltage source. It is a non-destructive qualitative** test long established and defined by IEEE and other standards. It is easily performed, relatively economical, and it provides useful results the operator can interpret and act on.

Why Choose the TD-65E?

Using the TD-65E with the HVI VLF-65E permits the user to **perform all TD tests possible and wirelessly communicate** the results to either the VLF itself for display and data collection and/or to a laptop with HVI custom application software written solely for the TD-65E. **There is no better alternative.** Another reason: HVI has been supplying the world with VLF and Tan Delta since 1998 with more models, great voltage range, higher power capability, **and the HVI sales and service care and support that is unmatched.**

Tests for MV Cable & Rotating Machinery

- VLF Withstand
- VLF Tan Delta
- VLF Withstand Test with monitored TD
- VLF Partial Discharge testing with add'l. access.

World Standards Met

IEEE 400, IEEE 400.2, IEEE 433, DIN VDE 0276, CENELEC HD620 S1, NEETRAC CDFI, & others



TD-65E Tan Delta Transducer

Features & Operations		Specifications
Voltage Measurement	Range Accuracy & Resolution	1 - 65 kV peak/1 - 38 kV rms 1% & 0.1 kV peak
Current Measurement	Load Range Accuracy & Resolution	60 mA rms 1% & 1 μ A rms
Tab & Measurements	Load Range Accuracy & Resolution	Freq: 0.1 Hz - 0.01 Hz, 5 nF - 10 μ F 1.0 x 10 ⁴ & 1 x 10 ⁵
Communications	Range ~ 30 m TD-65E » VLF-65E & TD-65E » PC Appl.	XBee 802.15.4 (not Bluetooth)
Power Input - Battery	Alkaline Rechargeable NiMH	2 "D" cells, approx. 8 hrs. Battery life Optional Package
Dimensions	TD Transducer w/Tripod TD Carrying Case	6" x 8" x 18" (152 x 203 x 457 mm) 22.5" w x 15" d x 11.75" h (572 x 381 x 298 mm)
Weight	TD Transducer - Tripod TD w/Pelican Type Case	7 lbs / 3.2 kg 40 lbs / 18.14 kg (with equipt) plus HVI canvas bag
Input Cable Connection - HV		MC Connector - Male 120 square mm
Output Connection - HV		1/4 – 20 male thread w/accessories
Ground Connection		1/4 – 20 stud w/wingnut
Environmental Requirements		Operating temp: - 10°C to + 50°C (122°F) Storage temp: - 25°C to + 65°C (149°F) Humidity: 80% up to 31°C (88°F)



ISO 9001:2008

31 County Rt. 7A • Copake, NY 12516 • (518) 329-3275 • Fax: (518) 329-3271
sales@hvinc.com • www.hvinc.com

High Voltage, Inc. designs and manufactures high voltage test equipment for utility and industrial applications. Products include VLF AC hipots, fault locators/thumpers, AC and DC hipots, aerial lift testers, HV dividers, oil dielectric testers, and more.

MV/HV Cable Testing – VLF Technology

VLF Withstand – VLF Tan Delta – VLF Partial Discharge

High Voltage, Inc. offers VLF test equipment for all medium and high voltage cables up to 161 kV.

Diagnostic field testing of cables is now here. All three technologies shown above are very well proven for testing MV cables. Any VLF model from HVI can be used to perform the three tests described. Our 200 kV VLF tests HV cables.

Withstand and Diagnostic field testing of medium and high voltage cable is now practical using HVI VLF technology along with commercially available Tan Delta and Partial Discharge measuring devices. The use of multi-ton, very expensive power frequency resonant equipment is no longer necessary. VLF products from HVI are far smaller, lighter, easier to transport, and less expensive: everything needed to bring factory cable testing methods to the field. These tests are **performed off-line, providing the most information possible.** Test procedures and test specifications are within IEEE and other Standards.

VLF Withstand Testing

The most basic use of the VLF is to perform a go/no-go withstand test to expose defects that cannot hold the test voltage. If a cable can't hold ~1.5 – 3 times normal voltage, depending on cable class, find out now. Let failure occur during downtime, make the repair, and not worry about that cable for many years. It is very useful following installation, repair, or to insure critical cables are sound. In situations where the user can tolerate a failure during the test, it is the simplest and most certain way to test a cable. Any defect severe enough to be driven to partial discharge is allowed to fail. Lesser defects and good insulation are unaffected. It is the ultimate diagnostic test.

Tangent Delta/Dissipation Factor/Loss Angle Testing

When a non destructive diagnostic test is preferred over a withstand test, there are proven options. The first technique and the most common is a **Tan Delta** test. This is a “global” test of the cable, providing the condition from end to end. Using a VLF as the voltage source and a separate divider to make the measurements, the voltage is raised while measuring the Tan Delta of the cable. If a cable is perfect, it behaves like a capacitor where there is a phase shift of 90° between the voltage and current. The more degraded the insulation and accessories are, the more this angle becomes less than 90°, as resistive leakage current is added. This change in the angle is easily measured and assumptions can be made about the degree of degradation. The absolute TD number is important, but more indicative is if the curve trends sharply upward as the voltage is raised, the cable is highly degraded. Test many cables and rate them as **Highly or Moderately Degraded, or Good.** This data is used to help prioritize cable replacement, injection, and/or to determine what other tests may be of value. TD testing is easily performed and interpreted.

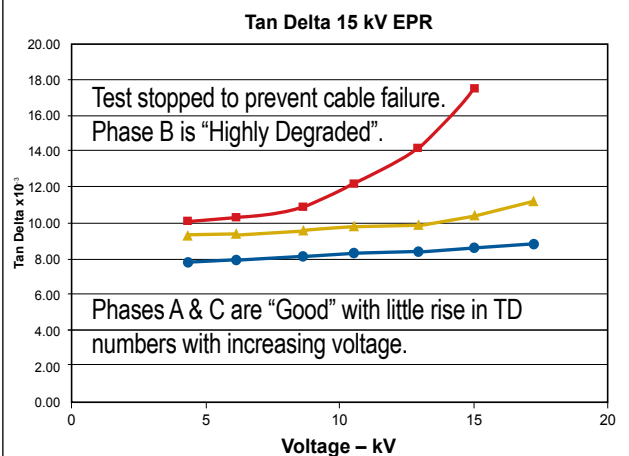
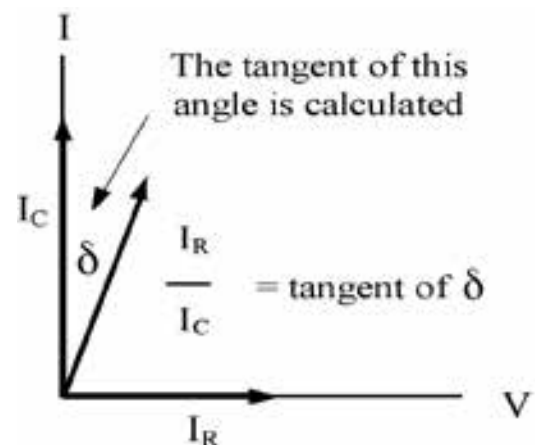

MV/HV Cable Testing – VLF Technology

Partial Discharge Testing

Partial Discharge testing is fairly new using VLF, yet proven and accepted. The obvious advantage to using VLF rather than power frequency systems is the smaller size, lower weight, far less power consumed, and price. PD testing attempts to locate defects and their severity along the cable path. While TD testing provides the overall health of the cable, **PD testing finds individual locations of electrical discharge**. The operator then makes a determination whether the level of PD is worrisome or acceptable. Any PD in the insulation at levels near or slightly above operating voltage is unacceptable, whereas accessories can survive with rather high levels of PD. This is where the interpretive nature of PD testing comes in. With no real guide as to what is and isn't acceptable PD and at what voltage level, particularly in accessories, interpretation can be difficult. Also measured are the Partial Discharge Inception Voltage (PDIV) and the PD Extinction Voltage (PDEV). Knowing where PD begins relative to applied voltage compared to normal operating voltage, and where the PD extinguishes when voltage is lowered, provides valuable data used in the interpretation. PD testing is of great value, although the most expensive and difficult to perform.

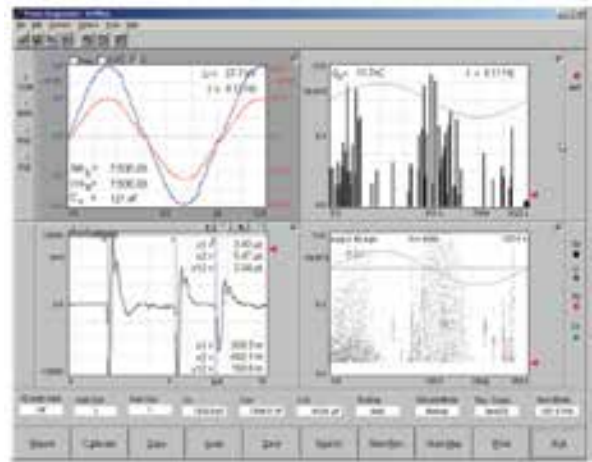

Sample PD Screen Shot: Location and Amplitude
Power Diagnostix Systems GmbH

Conclusion

All three methods of testing provide useful information, but different information. None are suited for every situation. None can provide all the information needed about a cable system. Ideally, all three technologies with the data they provide should be performed before making a decision. The cost of the test, the cost to buy the equipment, the ease of the test, the ease of interpretation, the skill of the operator necessary, the availability of the equipment, the cable design, age, ease of repair, the data needed to make cable maintenance decisions, and whether cable failure during the test is permissible are all vital in selecting what tests are best for your cable system.

No other company can offer as much as HVI. All three methods have been used for years and are well proven for testing cables. Select one or more to learn as much as possible about your cables



200kV VLF Withstand, VLF TD & VLF PD Test Truck
Inducor Ingenieria S.A. Argentina



Not shown: 50 kV, 60 kV, 65 kV & 200 kV
Load ratings from 0.4 μ F – 50 μ F

rugged

CDS Series *Cable Fault Locators* *Thumpers - Surge Generators*

HVI offers the most complete fault locator packages available for primary cable.

HVI offers the only VLF Thumper combination – ideal for cables up to 25kV.

HVI can offer more for fault location and cable testing than any other.

HVI can match a VLF hipot to our thumper for total cable care.

Get More from HVI:

- **Three Fully Variable Hipot Outputs**
- **Three Full Energy Discharge Outputs**
- **The Highest Burn Current Available**
- **Only VLF Thumper Available**
- **TDR/Radar Ready**
- **Rugged Design**



dependable

HVI – The Cable Testing & Fault Locating Company

HVI has extensive knowledge and field experience in fault locating and cable testing along with the best tools for the job. Fault locating requires more than just a thumper. Efficient fault locating requires the convergence of knowledge, methodology, and the right hardware. A total approach is needed to get the job done quickly to minimize customer outage time and damage to the cable system. This includes knowledge of the cable systems design, construction, and history, accurate maps, proper fault locating procedures, the right thumper, some cable burn down method, use of tdr/radar, and a top level acoustical & electromagnetic listening device. HVI can assemble the best system and approach possible to meet all needs from 5kV – 230kV cable.

Q. Why Choose HVI Thumpers? A. HVI Thumpers Offer All the Features Needed.

When fault locating, remember this: do no harm. Don't harm you insulation and accessories by thumping your 15kV cable at 25kV for hours looking for a fault. Use proper methods and technologies. The goal should be to thump at the lowest possible voltage yet deliver the highest possible energy to find the fault. Locate the fault without making more. To do this you need a thumper with a **variable hipot output, multiple full energy discharge outputs, and ample burn current** to condition a fault to arc at a lower voltage. HVI thumpers offer all the features and power necessary: many others don't. **Don't handicap your fault finding efforts by spending the same or more for ½ a thumper. HVI thumpers provide all the tools needed.**

- **Fully Variable Hipot Output On All Three Voltage Settings**

Needed to identify faulted cable, show breakdown voltage to help choose tap, burn fault, hipot cables after repair

- **Highest Burn Current**

Burns down faults to permit thumping at lower, less damaging voltage levels. Some vendors offer no hipot/burn

- **Three Output Voltage Taps All At Full Energy**

Allows thumping at lower voltages. Noise of maximum joules @ 5kV = noise of maximum joules @ 20kV

- **Variable Discharge Rate:** 6 – 10 second discharge/thump rate. Faster and slower discharge rates are not advisable

- **TDR/Radar Ready**

Use your old TDR or buy a new one. A separate TDR box is advantageous over a TDR built-in to the thumper: greater flexibility, versatility, ease in service, use without thumper, take to office for downloading and training, etc.

- **Battery Operation**

HVI thumpers are *not* battery operated. Thumpers of this class that are battery operated must sacrifice other necessary features, like variable hipot outputs and cable burning, missing half of what a thumper should be. In addition, some have a long 15 seconds between discharges, greatly slowing the fault locate. Also, battery charge times are short, assuming that you remembered to keep it charged between uses. To get battery operation is not worth the sacrifice.

Controlled Energy Thumpers With Burn Capability a Necessity

Due to the known problems associated with DC cable testing, most utilities worldwide have abandoned DC testing of solid dielectric cable (many have switched to VLF AC testing), or greatly reduced their test voltage levels, yet they then thump cables at voltages of 2 – 3 times normal line-to-ground voltage. They find the fault but make more in the process. This is avoided by using HVI thumpers with three output voltage taps, and high burn currents used to reduce fault impedances to permit lower voltage thumping. HVI thumpers can thump at voltages below normal line-to-ground voltage yet still deliver maximum joules, thereby minimizing damage to the cable system while delivering full energy to the fault needed for rapid location.

$$\text{Energy} = \text{Watt Seconds} = \text{Joules} = \frac{1}{2} CV^2 = \text{Fault Arc Intensity} = \text{Noise} = \text{Electro-Magnetic Discharge}$$

Problem: To deliver the full joules of energy possible to a fault, the capacitors within a thumper must be charged to the maximum voltage. With the wrong thumper, this often results in thumping a cable at an excessive voltage, causing significant damage to insulation and accessories. Since the applied voltage is a square function ($\frac{1}{2} CV^2$), if the thumper is at 2/3 voltage, only 45% of the joules are delivered to the fault. At half voltage only 25% energy is delivered, making the fault hard to hear. Either fault locating takes far longer than necessary or the crew gets impatient and turns the voltage all the way up to get the loudest bang. The fault is found but more are made. This practice can and should be avoided.

Solution: Use a multi-tapped, “controlled energy” thumper like those from HVI. With three output voltage taps and ample burn current to condition faults, thumping can be performed at voltages far lower than before. Find your fault quickly while avoiding damage. Wouldn't you rather thump at 5kV instead of 20kV, as long as the discharge energy, or noise, was equal? **The measure of a good thumper is not the maximum voltage it can discharge, but the minimum voltage still capable of delivering the full energy. For instance, our 5/10/20 kV output model is a far better choice than the 12.5/25kV model from others.**

Model CDS-2010U & CDS-2010UF



Input:	CDS-2010U: 120 V, 60 Hz, 25 A CDS-2010UF: 230 V, 50/60 Hz, 15 A
Hipot Output:	0 – 5/10/20 kVdc
Hipot Burn Current:	400/200/100 mAdc
Discharge Output:	1000 Joules at each output voltage
Discharge Rate:	6 – 10 seconds
TDR Interface:	Arc Reflection & Current Impulse
Size:	27" w x 27" d x 48" h 686 mm w x 686 mm d x 1219 mm h
Weight:	260 lbs/118 kgs
Cable Outputs:	50' HV, return, & ground
Other Features:	Rugged, transit protected meters External Interlock Emergency OFF mushroom switch Internal heater to limit condensation

With its 20kV output, the CDS-2010U is good for fault locating cables rated up to 35kV, having a line to ground voltage of 20kV. The high burn current of 400mA can be used to condition a fault to reduce its arc over voltage to permit thumping at a lower and less damaging voltage level, yet still at full energy. The CDS-2010U can thump a cable at just 5kV yet deliver 1000 joules. Find your fault without making more.

There is no better thumper. The CDS-2010U offers the complete package: three full joule output voltages, three variable hipot outputs, the highest burn current, rapid discharge rate, tdr/radar ready, and its rugged design holds up to years of use. Another plus: all HVI Thumpers use EPR high voltage output cable rather than XLPE. EPR stays flexible in cold weather. HVI thought of everything.

Ideal for Coops, Small Municipals, IOU URD and Industrials



CDS-3616U(F) & CDS-3632U(F) - The Network Systems Thumper



Input:	CDS-3616U/3632U:	120 V, 60 Hz, 25 A
	CDS-3616UF/3632UF:	230 V, 50/60 Hz, 15 A
Hipot Output:	0 – 9/18/36 kVdc	
Hipot Burn Current:	280/140/70 mAdc	
Discharge Output:	CDS-3616U(F): 1600 Joules at each output voltage	
	CDS-3632U(F): 3200 Joules at each output voltage	
Discharge Rate:	6 – 10 seconds	
TDR Interface:	Arc Reflection & Current Impulse	
Size:	25" w x 29" d x 44.5" h (30" w with attached cable reel)	
	635 mm w x 737 mm d x 1130 mm h	
Weight:	1600J model: 375 lbs/170 kgs	
	3200J model: 450 lbs/204 kgs	
Cable Outputs:	100' HV, return, & ground	
Cable Reels:	100' HV & return cable reel	
Optional	100' ground cable reel	
	Thumper equipped with 10' output cable with MC connection to reel	
Other Features:	Rugged, transit protected meters	
	External Interlock	
	Emergency OFF mushroom switch	
	Plexiglas panel to view grounding solenoid	
	Internal heater to limit condensation	

CDS-3616U(F) & CDS-3632U(F) (suffix F for 230 V 50/60 Hz models)

These two models are ideal for Network Systems or other situations where cables are rated up to 69kV, oil insulated cables, and/or long cable lengths are encountered. The powerful 3200 joule pulse makes fault locating easier using acoustical and electromagnetic detection devices. With 280 mA of burn current, faults can be rapidly reduced to low voltage levels, permitting thumping at lower and less damaging voltage levels. The CDS-3632U can thump at 9kV, 18 kV, or 36 kV yet deliver 3200 joules.

There is no better thumper. The CDS-3616/32U offers the complete package: three full joule output voltages, three variable hipot outputs, 280 mA burn current, variable discharge rate, tdr/radar ready, and its extremely durable design holds up to years of use. Another plus: all HVI Thumpers use EPR high voltage output cable rather than XLPE. EPR stays flexible in cold weather. HVI thought of everything.

Thumper Specification Review

Don't handicap your fault finding efforts by buying a thumper with only half the features necessary.

For the same money, you can buy a full featured thumper. When specifying, require:

- At least two full joule output voltage settings, preferably three, and with at least 1000 joules of energy
 - A variable hipot output with high burn current of at least 200mA
 - Variable discharge rate from 6 – 10 seconds
- A remote TDR/radar, not one built-in, for flexibility, versatility, ease in service, and ease in use

Compare HVI Features and Specifications to Any Other – Why Utilities Choose HVI

Features	CDS-2010U	CDS-3616U	CDS-3632U
Output Voltages	0 – 5/10/20 kV	0 – 9/18/36 kV	0 – 9/18/36 kV
Joules	1000 @ 5/10/20 kV	1600 @ 9/18/36 kV	3200 @ 9/18/36 kV
Constant Energy	Yes. On all taps	Yes. On all taps	Yes. On all taps
Variable Hipot	Yes. On all taps	Yes. On all taps	Yes. On all taps
Hipot/Burn Rating	400 mA	280 mA	280 mA
Discharge Rate	6 – 10 seconds	6 – 10 seconds	6 – 10 seconds
TDR/Radar Ready	Yes	Yes	Yes

HVI Offers the Complete Package – Don't Buy Less

VLF Thumper Combination - VT33(F)

VT33 - Complete Cable Care For 5 – 25kV Cable

With cable diagnostic testing becoming more common, the need for fault locating will rise. If a cable cannot withstand the test voltage, failure will occur, requiring fault locating. If you're in the market for a thumper, why not get one with a VLF hipot built-in to test the AC integrity of the cable following repair. The VT33 incorporates a powerful VLF hipot, a VLF Burner that rapidly reduces a fault's impedance (arc-over voltage), TDR/radar capability, and continuous discharge for pinpointing the fault. Suitable for cables up to 25 kV. HVI puts all the tools needed in one box.



- VLF test cables per IEEE400.2, VDE 0276, CENELEC, etc.
- Pre-locate faults using a connected TDR/radar
- VLF Burn faults to lower arc-over voltage
- Pinpoint fault with continuous thumping

Input:	VT33: 120V, 60 Hz, 10A VT33F: 230V, 50/60 Hz, 5A
VLF Hipot Output:	0 – 33 kVac peak @ 0.1 Hz
Load Capability:	1 μ F or more than 1 mile of 15kV cable
Discharge Output:	0 – 13 kVdc @ 760 joules
Discharge Rate:	Every 8 seconds
VLF Burner:	Arcs cable every few seconds
TDR Interface:	Arc Reflection & Current Impulse
Size & Weight:	28" w x 26" d x 44" h, 245 lbs. 711mm w x 660mm d x 1118mm h, 111kg
Cable Outputs:	50' (15m) shielded HV cable & ground

Very Low Frequency (VLF) AC Cable Testing

Most of the world has quit testing cables with DC voltage. It is well known that testing cables at the historically applied 4 – 5 times normal voltage causes solid dielectric cables to fail prematurely. Also, DC leakage currents tell little about the true condition of a cable's insulation and even less so about its accessories. With DC out of favor, something else had to be found. Enter **VLF withstand, VLF Tan Delta, and VLF Partial Discharge testing.**

A VLF AC test set is just an AC hipot but with an output frequency of 0.1 Hz or lower, rather than 50/60Hz. The lower the frequency the lower the current and power required to apply an AC voltage to a high capacitance load like cable. It requires 600 times less power to AC hipot a cable at 0.1 Hz as at 60Hz. With the present day VLF products available from HVI, it is now possible to AC hipot a cable to verify its integrity. The VLF hipot enables users to AC test long cables in the field with relatively portable and affordable equipment. There is no better way to verify the integrity of a cable following repair than to apply 2 – 3 times normal AC voltage for a period of time. The other methods used don't get the job done: DC hipotting, a 5kV megohmmeter test, hot stick adaptors that apply far less than the cables operating voltage, and/or a soak test. Don't be back in the same neighborhood a week after a repair because of additional damage resulting from the original in-service failure, damage to adjacent cables, damage inflicted to the repaired cable by over voltage thumping for hours, or because of a faulty repair. VLF it before re-energizing for the maximum assurance that the cable is healthy.

HVI offers VLF products from 28kV to 200kV. Let us help you with all your cable test and fault location needs. In addition to using the VLF to proof test a cable, add a Tan Delta and Partial Discharge accessory to perform cable diagnostic testing. HVI is the cable test company.

MV & HV Cable Fault Locating & VLF Testing

VLF + Thumper = Ease In Fault Locating HV Cables

5 kV – 25 kV Cable Systems

The VT33 VLF Thumper Combination is the best approach: VLF test cables, use VLF output for diagnostic cable testing, use VLF Cable Burner to reduce fault voltage, fault locate with 13 kV @ 760 joules, use TDR/radar for sectionalizing and for pre-locating faults. If a conventional thumper is desired, the CDS-2010U is the most complete and full featured device available.

35 kV Network Systems

For 35 kV cable, solid or fluid filled, a popular combination of products is the VLF-6022CM VLF hipot and the CDS-3632U Thumper. Cable reels containing high voltage, return, and ground cables are also supplied, with various MC connector attachments. The VLF-6022CM is designed to VLF hipot cable rated up to 35kV. It can also be used as a voltage source for **Tan Delta and Partial Discharge** cable diagnostic testing. The CDS-3632U, with its 3200 joule discharge energy, offers the power needed to make good use of electro-magnetic and acoustic detection devices as well as work very effectively for Current Impulse locating on PILC.



VLF-6022CM
0-60kVac peak @ 0.1 – 0.02 Hz
Load rated to 5.5 μ F

69 kV - 230 kV Cable Fault Locating

For high voltage cable fault locating on cables up to 230 kV, there are not many options. One very good approach is to use a Very Low Frequency AC hipot and the CDS-3632U. The VLF is used to burn down the cable fault to a voltage arc-over level less than the discharge rating of the surge generator. Once a fault is made to arc over at less than ~30kV, then the 36kV @ 3200 joules discharge of the CDS-3632U is sufficient to find the fault. The VLF hipot can then be used to perform a VLF AC withstand test after the repair to verify the AC integrity of the cable and the repair. Either a 120kV or 200kV VLF can be used.

Using a VLF hipot designed for **cable burning** is the most effective means of reducing the impedance of a fault to reduce its arc-over voltage to enable the use of smaller and more conventional thumpers. A combination of VLF, needed for AC hipotting the cable and as a voltage source for tan delta and partial discharge testing, and our CDS-3632U is the best way to go. In the VLF Burn Mode, the VLF applies its output voltage to the cable. The VLF voltage rises until the cable arcs. The VLF continues to operate, causing the cable to arc in the other polarity. This continued arcing in successively opposite polarities rapidly burns down the fault. The arc current of the VLF combined with the stored energy of the cable dumped into the fault every half cycle gets the job done far faster than DC burn down sets.

69kV cable

69kV – 138kV cable

138kV – 230kV cable



VLF-90CM
0 – 90 kVac @ 0.10 – 0.02 Hz
Load rated to 2.75 μ F



VLF-12011CM
0 – 120kVac @ 0.10 - 0.01 Hz
Load rated to 5.5 μ F



VLF-200CMF
0 – 200kVac @ 0.10 - 0.02Hz
Load rated to 3.75 μ F

Other VLF models are available, as well as Tan Delta and Partial Discharge test equipment.

ACCESSORIES

HVI can provide all the accessories needed to put together a complete fault locating system. Fault locating is an approach, not just a thumper. Don't spend a lot of money on a thumper but not the extra few thousand for a top level listening device to make it most effective. Don't thump for hours wasting time and damaging your cable when a TDR trace can show you the fault location in two minutes, quickening sectionalizing and repair. Consult with HVI on the accessories most appropriate for your situation. We have our favorites but can supply anything needed. For a TDR, nearly any model now available works great.

Cable reels



Acoustical/Magnetic listening devices



Accessories with MC Connectors for Thumper and VLF HV output



Fitted with 12" of cable and female MC connector



Hot Line clamp
Hotstick compatible



MC vise grip



15kV & 25kV
probe for bushing.
Hotstick compatible

TDR/Radar

All HVI Thumpers offer both the arc reflection and current impulse method of fault location.

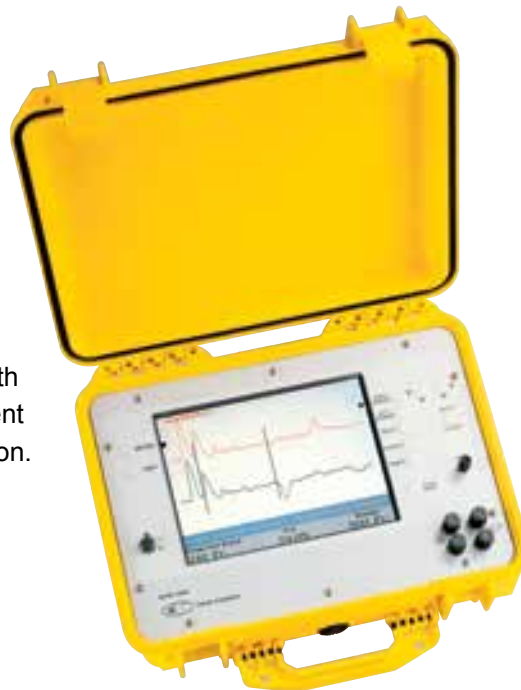

All HVI Thumpers offer both a signal and remote trigger TDR connection to accommodate all types of TDR designs.

Portable AC Hipot Test Sets

0-10 kVac, 0-30 kVac, 0-50 kVac and 0-100 kVac



Model PFT-503CM
(0-50 kVac)



Model PFT-301CM
(0-30 kVac)



Model PFT-1003CM
(0-100 kVac)



Description

The **PFT Series** of portable AC hipot test sets are ideal for a variety of field and repair shop testing applications. These inexpensive, compact and light weight units are rugged and reliable. Our 3 kVA models feature capacitive load compensation enabling full load testing with a power draw of 1.5 kVA while operating from a conventional line input.*

Applications

These units are well suited for testing overhead apparatus, vacuum bottles and interrupters, switch gear, bus duct, motorized vacuum switches, reclosers, bushings, fuses and arrestors, linemans safety products, small transformers, electrical components and motors.

For AC cable testing, we offer a variety of Very Low Frequency AC hipots that are well suited for testing long cable lengths. Please contact our sales office for more information on cable testing applications.

Control Features

Control features on our 3 kVA models include a dual range kilovoltmeter and triple range output current meter. All of our units feature continuously adjustable output voltage control, external safety interlock, zero start safety interlock, self resetting over current protection, guard/ground return mode, HV on/off and main power pushbuttons and ruggedized meters with glass windows that eliminate static buildup.

An optional fault burning mode is available for our 3 kVA models and for increased portability, a hand cart option is available for the PFT-1003CM.

Advantages

We offer four single piece, shielded output cable models: PFT-103CM, PFT-301CM, PFT-303CM and PFT-503CM. A two piece 100kV model PFT-1003CM with a top toroid termination (no output cable) is also available. In addition, we offer an ALT-120/60 that is specialized for Aerial Lift and Bucket Truck testing applications and suitable for general AC high voltage testing applications. Custom models are available from 10kVac to 300kVac output.

Portable AC Hipot Test Sets

	PFT Model Specifications				
	PFT-301CM	PFT-103CM	PFT-303CM	PFT-503CM	PFT-1003CM
Input	120V, 60 Hz, 10A or 230V, 50/60 Hz, 5A	120 V, 60 Hz, 15A, or 230 V, 50/60 Hz, 8A			
HV Output	0-30 kVac, 1kVA resistive load 33 mA current	0-10 kVac, 1kVA resistive load 3 kVA capacitive load Up to 300 mA current	0-30 kVac, 1kVA resistive load 3 kVA capacitive load Up to 100 mA current	0-50 kVac, 1kVA resistive load 3 kVA capacitive load Up to 60 mA current	0-100 kVac, 1 kVA resistive load 3 kVA capacitive load Up to 30 mA current
Ground Current: at full output voltage in ground mode but not guard mode	2.5 mA	1.0 mA	14 mA	20 mA	2 mA
Output Termination	20 ft. (6m) long shielded output cable with alligator clamp and hook for test connections				Top Toroid (No output cable)
Duty	1kVA, 1 hour ON, 1 hour OFF 700VA: continuous	3kVA: 1 hour ON, 1 hour OFF 1kVA: continuous			
Distortion	<5%				
Meter Accuracy	2% F.S.				
Kilovolt Meter	3.5 inch Scaled 0-30 kVac	3.5 inch Scaled 0-5/10 kVac	3.5 inch Scaled 0-12/30 kVac	3.5 inch Scaled 0-25/50 kVac	3.5 inch Scaled 0-50/100 kVac
Current Meter	3.5 inch Scaled 0-40 mAac	3.5 inch Scaled 0-3.0 mAac with x1, x10 x100 Range Multiplier	3.5 inch Scaled 0-1.0 mAac, with x1, x10, x100 Range Multiplier		
Control Dimensions	17" w x 11.5" d x 14" h 431 mm w x 292 mm d x 365 mm h	21" w x 11.25" d x 15.25" h 533 mm w x 286 mm d x 387 mm h			
H.V. Tank Dimensions	High Voltage Tank included in controls				13" w x 13" d x 22" h 330 mm w x 330 mm d x 559 mm h
Weight	45 lbs. (20kg)	62 lbs. (28kg)	75 lbs. (34kg)	75 lbs. (34kg)	Control-35 lbs. (16kg) HV Tank-85 lbs. (39kg)

Note: For 230 volt line input, an F is suffixed to the model number.



PFT-301CM Control Layout



PFT-503CM Control Layout

Advantages

Models below 100 kVac are single piece units with a shielded cable output for fast and easy test setup. The PFT-103CM, PFT-303CM, PFT-503CM, and PFT-1003CM are compensated enabling testing of 3 kVA loads with a power draw of 1.5 kVA and operate from a conventional electrical source*. In addition, these units include a dual range kilovolt meter, triple range output current meter and a guard/ground return mode enabling the operator to measure the total current to ground or only the current flowing through the sample under test.

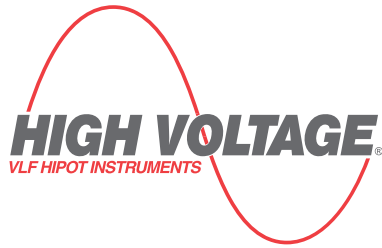

PFT-302CE AC High Voltage Test Set

0-30 kVac @ 2 kVA | One Piece Portable - Cable Output

CE PD FREE



Our Company and Our Products

HIGH VOLTAGE, INC. manufactures the most advanced test equipment available for high voltage proof and preventive maintenance testing of electrical apparatus. Our products are designed to meet the needs of utilities, industrials, testing services, electrical contractors, motor & generator shops, and others needing to HV test.

Our products offer features and specifications not found elsewhere. Many are the leading sellers world-wide, as over 50% of our sales are international. *HVI – the source for HV test equipment.*

- Very Low Frequency (VLF) AC
- VLF Tan Delta and Partial Discharge
- DC Hipots w/ HV Megohmmeter
- AC Hipots for field use
- AC Dielectric Test Sets up to 40 kVA
- Aerial Lift Testers
- Cable Surge Generators/Thumpers
- Oil Dielectric Testers
- HV Divider
- Custom AC & DC HV tanks

Description

The **PFT-302CE AC Dielectric Test Set**, provides continuously adjustable AC output voltage used to provide a pass/fail AC Voltage Withstand Test on high voltage apparatus: switchgear, circuit breakers, reclosures, vacuum bottles, hot sticks, rubber products, motor windings, bus duct, insulators, and any other apparatus needing an AC voltage insulation proof test. It is portable, affordable, and easy to use. **It is our CE marked version of our AC Hipots within our PFT Series of testers.**

Features

- CE
- One piece portable design
- Digital Voltage and Current metering
- Memory voltmeter at time of fault
- Guard/Ground switch with isolated load return circuit
- User adjustable secondary overload circuit settable from 10 – 110%
- Primary current overload backup breaker protection
- Ground shielded output cable for ease in connecting load
- Shielded EPR HV output cable
- Rugged case with cushion grip handles
- “Zero Start” and external interlock provision. Keyed Main Power switch
- PD FREE <10PC

Specifications

Input:	230 V, 15 amps, 50/60 Hz, single phase
Output:	0 – 30 kVac, up to 67 mAac depending on load, sinusoidal
Output cable:	20 ft/6 m EPR shielded cable with battery clamp termination
Duty rating:	2 kVA, one hour ON - one hour OFF, 1 kVA continuous
Volt Meter:	3.5 digit LED scaled 0 – 30.0 kVac (rms) +/- 1% accuracy
Current Meter:	3.5 digit LED scaled 0 – 67.0 Milliampers (rms) +/- 1% acc.
Size/Weight:	23”w x 11.5”d x 15.5”h, 77 lbs. 585 x 293 x 395 mm, 35 kg

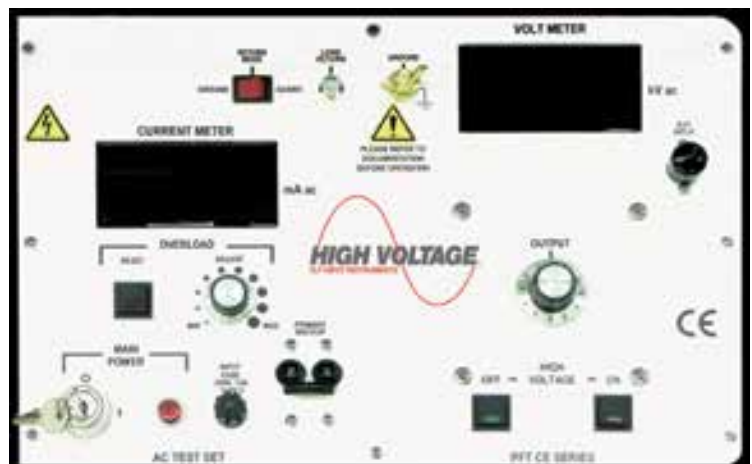

Test Motors & Generators rated to 6.6 kVac

AC Withstand & Diagnostic Assessment Testing Stator Bars, Coils, Insulators, Bus Duct . . . etc.

Dual Outputs: 0 - 6 kVac @ 1 A & 0 - 12 kVac @ 500 mA

0 - 6/12 kVac @ 6 kVA AC Test Set



Test up to
6,600 V coils

Advantages

- High Power Mobile AC Supply
- Ideal for Field or Shop Testing
- AC Proof Test High μ F Loads
- Corona Free Output <10pc
- Use for Tan Delta/Power Factor & Partial Discharge Testing
- Portable & Easy to Maneuver
- Standard hipot type design, easy and quick to use with no programming necessary

AC Dielectric Test Sets from HVI

PFT Series: 10 kV - 200 kV up to 3 kVA
HPA Series: 5 kV - 400 kV up to 50 kVA

Popular Motor Test Model



Model PFT-103CM
0 - 10 kVac @ 3 kVA
up to 300 mA current
one piece portable
shielded cable output
guard/ground circuit
rugged & reliable

Description

The model **FPA-12/066F AC Dielectric Test Set** provides continuously adjustable AC high voltage to perform pass/fail AC Withstand testing and for use as a voltage source for diagnostic testing of high voltage apparatus, like motor & generator windings, bus duct, switchgear, etc. The **FPA-12/066F** is rated for 6 kVA of test power from two full kVA outputs: **0 - 6 kVac @ 1 amp and 0 - 12 kVac @ 500 mA**. It offers the motor test features needed, the convenience of a shielded EPR output cable, and is corona free to < 10 pc. It is provided in a mobile, rugged, and reliable package.

Application note: AC voltage testing is the proper method to use to test the AC operating integrity of most apparatus. AC testing usually requires higher test current than DC testing. The AC load current is determined by the load's capacitance and the test voltage. It can be calculated by using the formula $A = 2\pi fCV$ with C in farads and V in volts. Check your charging current needs to select a hipot with enough kVA. For more information, read the HVI application data and the **PFT Series & HPA Series** product line brochures from HVI.

Features

- Two Full kVA Voltage Outputs
- Low Partial Discharge output <10 pc
- Voltage Output Selected LEDs
- Adjustable Overload from 10% – 110%
- Overload Backup at 120% of pri. current
- Load Burn mode to help find faults
- Shielded output cable for ease in use
- Keyed Emergency Off switch
- Zero Start & External Interlock
- Rugged Metering - Digital Optional
- Warning Lights - Green & Red
- Isolated Load Return with Guard/Ground switch
- Dual Range Voltage - Triple Range Current metering
- Simple, manual controls for ease in use - no programming



Specifications

- HV Output:** 0 - 12 kVac @ 500 mA or 0 - 6 kVac @ 1000 mA
Duty rating: 6 kVA @ 1 hr. ON/1 hr. OFF, 5 kVA continuous
HV Section: Transformer - Air Insulated
Input: 230 V, 26 amps, 50/60 Hz, single phase
Output cable: 20' / 6 m EPR shielded cable with battery clamp termination
Volt Meter: 3.5" Analog with scaling of 0 - 3/6/12 kVac
Current Meter: 3.5" Analog with scaling of 0 - 250/500/1000 mAac
Size/Weight: 20.5" w x 23" d x 47" h, 235 lbs. (height incl. warning lamps)
521 w x 584 d x 1245 h mm, 107 kg

 HVI: The World's VLF Source
All HVI Products are **Made in the USA**

HVI: The high voltage test equipment source for Motor/Generator OEMs and rewind shops

Field Portable AC Dielectric Test Set

Model: FPA-12/066F 0 - 6/12 kVac @ 6 kVA

Ideal for Testing Motors & Generators rated up to 6 kV & other apparatus
 Controls and Connection Details – also see product brochure



Warning Lights
 Red - HV On
 Green - Power On



Three ranges for each output voltage tap
 0 - 250 mAac, 0 - 500 mAac, 0 - 1000 mAac



Two ranges for each output voltage tap
 6 kVac Output: 0 - 3 kVac & 0 - 6 kVac
 12 kVac Output: 0 - 6 kVac & 0 - 12 kVac



Auxiliary Power: 120 V @ 2 A
 Ground Connection for Aux. Power
 3 Fuses: two 2 A SloBlo & one 3 A
 External Interlock Connection
 Load Return BNC for Guarded Current
 Input Power cord

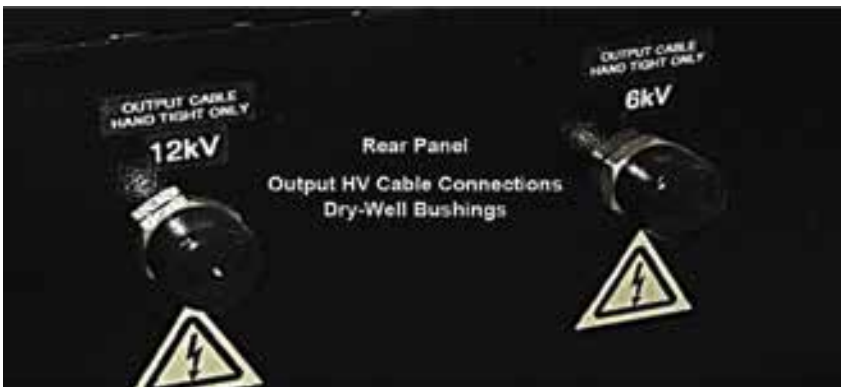

 All HVI Products are
Made in the USA

durable

HVI offers a full line of AC Dielectric Test Sets up to 300 kV in voltage and 40 kVA in power. Conventional test sets are available as well as specialty models, like several designed specifically for motor winding testing. They are all rugged in design, with either oil filled steel or fiberglass high voltage sections and well designed, attractive controllers with all the features needed. Custom models are also available upon request. If lower power models are sufficient for your application, then consider our standard, portable PFT Series of 1 kVA and 3 kVA AC Hipots, available from 10 kV – 100 kV.

AC DIELECTRIC TEST SETS



HPA-505FC1
0-50 kV @ 5 kVA

3 kV – 300 kV

5 kVA – 40 kVA



HPA-20020FC3
0-200 kV @ 20 kVA

Also available are just the high voltage sections used within the test sets described here, like our 50 kV @ 10 kVA HV tank for testing rubber gloves, aerial lift liners, hot sticks, and other similar loads.

Multiple Controller Options

economical

Selecting an AC Dielectric Test Set

AC high voltage testing requires higher power/current ratings than when DC testing the same load. There are several parameters that must be considered when selecting an AC test set, the most important one being the capacitance of the load, which dictates the power required from the test set. Following are several considerations when specifying a test set:

Voltage Output

Select a test set with perhaps 20 – 25% more voltage than presently needed for possible future increases in testing standards or changes in application. However, the output current of the test set is based on the kVA rating at full voltage. Any increase in the output voltage rating for the same kVA rated test set will proportionately decrease the current rating.

Power/Current Rating

When AC testing, most loads appear capacitive. To apply high voltage AC at 50/60 Hz to capacitive loads requires higher power and current ratings from the test set than typical portable AC hipots can supply. A test set rated for 10 – 20 kVA may be needed depending on the load to be tested. The capacitance of the load must be known in order to calculate the required current at the required voltage. Don't undersize the set: select a test set with at least 20 - 25% extra power than believed needed. To determine the current needed from the test set, the following formula should be used:

$$A = 2\pi fCV$$

A = Test current required in Amps (A)

f = Test frequency in Hertz (Hz)

C = Load capacitance in Farads (F)

V = Test voltage in volts (V)

Another way to determine the current needed at the required test voltage is to apply a lower voltage to the load and measure the current. The current required at the actual higher test voltage should be fairly linear. For example: if your load draws 10 mA @ 5 kV it will draw approximately 100 mA @ 50 kV. Remember, an AC test set is a constant current device. The maximum output current is the same at any output voltage.

Duty Cycle

Most AC hipotting is performed for 60 seconds at a time. However, production testing may require consecutive tests over many hours. Most HVI AC test sets are duty rated for 50%, meaning full power can be delivered for one hour on followed by one hour off. The continuous duty rating is approximately 80% of full rating. Consult product specifications for details.

Partial Discharge Requirements

Many HVI AC test sets are rated for <10pc of partial discharge at full voltage, but not all. Generally, steel tank bushing output models are <10pc while models with fiberglass HV sections and/or a cable output are not. Consult factory.



HPA-1010FC3
10 kV @ 10 kVA
one piece design
with optional castors
and warning light



HPA-10010FC3
100 kV @ 10 kVA



HPA-055M
5 kV @ 5 kVA
Motor shop model
(Fig C1 controls)
with Burn Mode

AC Dielectric Models

5kVA

Input: 230V, 50/60Hz,
1 Ph, 25A
Duty: 5kVA
1 hr. On/ 1 hr. Off
4 kVA Continuous

VOLT. (kV)	MODEL	CURRENT (mA)	CONTROL SECTION					HV SECTION					TYPE
			W in mm	D in mm	H in mm	FIG.	WT LBS KG	W in mm	D in mm	H in mm	WT LBS KG		
10	HPA-105FC*	500	21 533	25 635	30.5 775	C1,2,3	200 91	none - one piece design					NA
30	HPA-305FC*	167	21 533	16 406	15 381	C1,2,3	75 34	13 330	13 330	21 533	95 43	steel	
50	HPA-505FC*	100	21 533	16 533	15 381	C1,2,3	75 34	13 330	13 330	21 533	95 43	steel	
75	HPA-755FC*	67	21 533	16 406	15 381	C1,2,3	75 34	13 356	13 356	21 635	95 43	steel	
100	HPA-1005FC	50	21 533	25 635	30.5 775	C1,2,3	145 66	18.5 470	18.5 470	34 864	300 136	steel	

10kVA

Input: 230V, 50/60Hz,
1 Ph, 50A
Duty: 10kVA 1 hr On/
1hr Off, 8 kVA Continuous

VOLT. (kV)	MODEL	CURRENT (mA)	CONTROL SECTION					HV SECTION					TYPE
			W in mm	D in mm	H in mm	FIG.	WT LBS KG	W in mm	D in mm	H in mm	WT LBS KG		
10	HPA-1010FC*	1000	21 539	25.5 648	47.3 1200	C2,3	390 177	none - one piece design					NA
30	HPA-3010FC*	333	21 533	25 635	30.5 775	C2,3	200 91	13 330	13 330	25 635	215 97	steel	
50	HPA-5010FC*	200	21 533	25 635	30.5 775	C2,3	200 91	13 330	13 330	25 635	215 97	steel	
75	HPA-7510FC*	133	21 533	25 635	30.5 775	C2,3	200 91	17 432	17 432	32 813	275 125	steel	
100	HPA-10010FC*	100	21 533	25 635	30.5 775	C2,3	200 91	18 457	18 457	37.5 953	325 147	steel	
150	HPA-15010FC*	67	21 533	25 635	30.5 775	C2,3	200 91	28 711	28 711	56.5 1435	825 374	fiberglass	

*Insert a 1, 2, or 3 to the model number in place of the * to specify which controller, described on page 4, will be needed.

20kVA

Input: 230V, 50/60Hz,
1 Ph, 90A
Duty: 20kVA 1 hr On/
1hr Off, 16 kVA Continuous

VOLT. (kV)	MODEL	CURRENT (mA)	CONTROL SECTION					HV SECTION					TYPE
			W in mm	D in mm	H in mm	FIG.	WT LBS KG	W in mm	D in mm	H in mm	WT LBS KG		
10	HPA-1020FC3	2000	22 559	25.5 648	47.3 1200	C3	530 241	none - one piece design					NA
30	HPA-3020FC3	600	22 559	25.5 648	47.3 1200	C3	300 136	17 432	17 432	25 635	300 136	steel	
50	HPA-5020FC3	400	22 559	25.5 648	47.3 1200	C3	300 136	17 432	17 432	25 635	300 136	steel	
75	HPA-7520FC3	267	22 559	25.5 648	47.3 1200	C3	300 136	17 432	17 432	32 813	325 147	steel	
100	HPA-10020FC3	200	22 559	25.5 648	47.3 1200	C3	300 136	18.5 470	18.5 470	37.5 953	375 170	steel	
150	HPA-15020FC3	133	22 559	25.5 648	47.3 1200	C3	300 136	35.5 902	35.5 902	56.5 1435	850 386	fiberglass	
200	HPA-20020FC3	100	22 559	25.5 648	47.3 1200	C3	300 136	35.5 902	35.5 902	56.5 1435	850 386	fiberglass	
300	HPA-30020FC3	67	22 559	25.5 648	47.3 1200	C3	300 136	35.5 902	35.5 902	82 2083	1150 522	fiberglass	

40kVA

Input: 230V, 50/60Hz,
1 Ph, 180A
Duty: 40kVA 1 hr On/
1hr Off, 32 kVA Continuous

VOLT. (kV)	MODEL	CURRENT (mA)	CONTROL SECTION					HV SECTION					TYPE
			W in mm	D in mm	H in mm	FIG.	WT LBS KG	W in mm	D in mm	H in mm	WT LBS KG		
10	HPA-1040FC3	4000	22 59	31 787	67 1702	C3	600 272	20 508	20 508	27 686	400 204	steel	
30	HPA-3040FC3	1333	22 59	31 787	67 1702	C3	600 272	25 635	25 635	35 890	500 227	steel	
50	HPA-5040FC3	800	22 59	31 787	67 1702	C3	600 272	25 635	25 635	35 890	500 227	steel	
75	HPA-7540FC3	533	22 59	31 787	67 1702	C3	600 272	25 635	25 635	37 940	550 250	steel	
100	HPA-10040FC3	400	22 59	31 787	67 1702	C3	600 272	30 762	30 762	41 1041	650 293	steel	

OPTION: On 5 kVA - 40 kVA models, air and steel tank only configurations, a 50% voltage tap rated full kVA is possible.

Motor Shop Models

VOLT. (kV)	MODEL	CURRENT (mA)	POWER (kVA)	INPUT Voltage (V)	INPUT Current (A)	FREQ. (Hz)	ONE PIECE - SIZE & WEIGHT					
							W in mm	D in mm	H in mm	CONTR. FIG.	LBS	KG
3	HPA-033MF	1000	3	230	13	50/60	18 457	21 533	49 1245	C1	145	66
5	HPA-055MF	1000	5	230	22	50/60	18 457	21 533	48 1245	C1	185	84

High Voltage Section Configurations

Except for the lowest 5 kVA, 10 kVA, and 20 kVA models that contain the HV section within the control cabinet, all models have a separate HV section. There are two HV section designs, a steel tank with a bushing output and a fiberglass cylinder with a toroid/spinning output. HVI can supply a one piece design on several of the lower voltage models, like the 10 kV model pictured in this brochure. A steel tank with a cable output on models rated up to 50 kV is possible on a custom basis. No HV output cable is provided on bushing and spinning output models. See the pictures in this brochure for examples of the various layout configurations.

Three Standard Control Packages – Variations Available On a Custom Basis

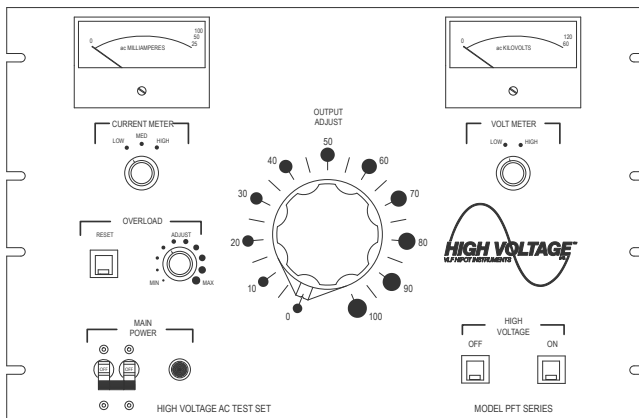

Fig. C1
Simplified Controls w/manual output voltage control – up to 5 kVA

Voltage meter: two range
Current meter: three range
Main Power breaker/indicating light
HV On/Off
Output Adjust control knob
Variable Overload w/reset

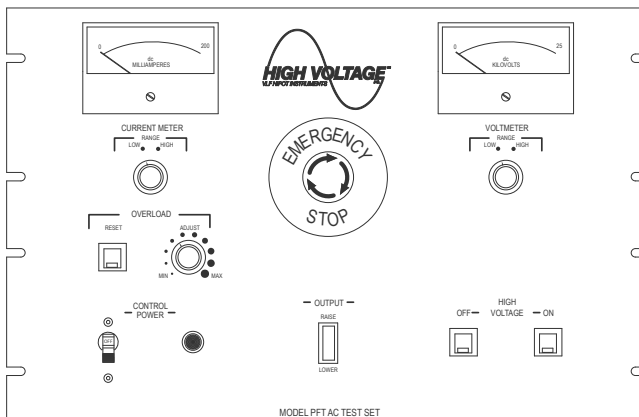

Fig. C2
Simplified Controls w/motorized output voltage control – up to 10 kVA

Voltage meter: two range
Current meter: three range
Control Power breaker/indicating light
HV On/Off
Voltage Raise/Lower control
Fixed voltage rate-of-rise
Variable Overload w/reset
Emergency Off button

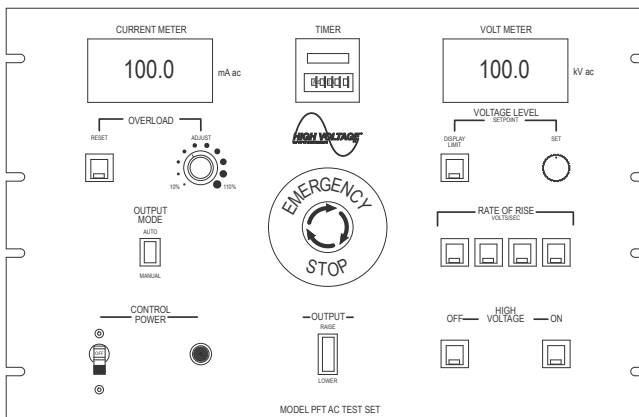

Fig. C3
Automatic Controls & Digital Metering – any kVA

Voltage meter: digital 3.5 digits
Current meter: digital 3.5 digits
Control Power breaker
HV On/Off
Output Mode Manual/Auto
Output Voltage Raise/Lower control
Four fixed volts/second rates-of-rise
10 – 100 seconds, consult factory
Test Dwell timer
Variable Overload w/reset
Emergency Off button

OPTIONS:

PLC Interface: Includes 0-10Vdc signal outputs for voltage and current monitoring, 0-10Vdc signal inputs for voltage and current set points, and normally open contacts for control of power on/off, remote enabled, overload, voltage raise & lower, and other controller packages. Consult factory for additional controller packages.

HPA Series AC Test Set Controllers

C3/P Option - C3 Controls with PLC interface

C4 Option - C3 Controls with 4.5 digit meters

C5 Option - Touch Screen programmable and PC interfaced

C3/P controller is the C3 controller that also offers input and output control provisions to interface with a remote programmable logic controller (PLC) or some other customer supplied controller. It can be operated in the Local mode using the front panel controls or in the Remote mode via customer supplied external controls.

Local Controls – front panel

Same as C3 controller but with OUTPUT MODE switch to engage remote control operation.

Remote Controls – inputs/outputs

Input Control terminals and Output Feedback signals are provided, permitting the remote control of the unit for most functions and output signals to communicate with the external controller. When in the REMOTE mode, all front panel controls are disengaged except for the Emergency Off and Volt and Current meters.

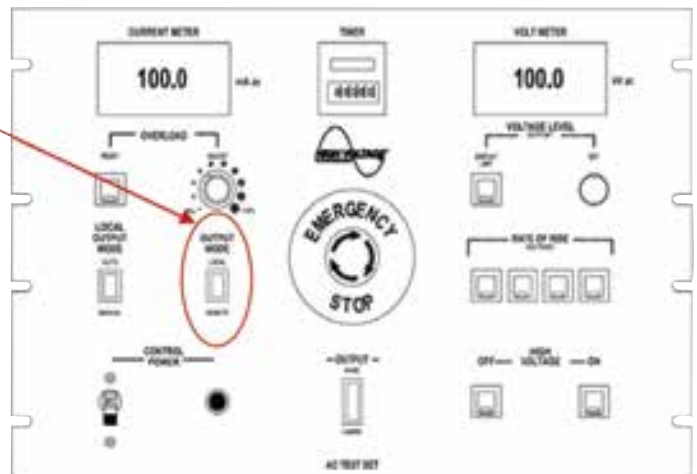

Input Remote Control Signals

Contact N/O: Close HV ON - Open HV OFF
Rate of Rise: 0-10V = 10s – 100s to full output
Contact N/O: RAISE – Close to operate
Contact N/O: LOWER – Close to operate
Contact N/C: Overload Reset – Open to operate
Overload Set Point: 0-10Vdc = 10 - 110% current

Output Feedback Signals

Remote Enabled: N/O
Main Power ON& High Voltage ON: N/O
Overload FAULT: N/O
Voltage: 0-10Vdc = 0 - 100% output voltage
Current: 0-10Vdc = 0 - 100% output current
Voltage return to 0 (automatic after overload): N/O

C4 Controls – C3 but with digital meters upgraded from standard 3.5 digits to 4.5

The C4 controller is the same as the C3 controller but offers 4.5 digit meters rather than the 3.5 digits found on the standard C3 controller. The 4.5 digit meters instead of 3.5 digits offer a higher resolution in reading the voltage and current displayed. The description of the C3 controller can be found on the rear of the HPA Series brochure.

C1, C2, & C3 controls are described in the HPA Series Brochure

Complete C5 controls can be found on its own specification sheet



Aerial Lift & Bucket Truck Tester Model ALT-120/60

50/60 Hz Portable AC Hipot

Description

The **ALT-120/60** is a portable high voltage AC test set designed to test aerial lifts. It is designed to meet all **ANSI A92.2** testing requirements for insulated work platforms, bucket trucks and liners. **The unit may also be used to test other electrical apparatus requiring AC voltage testing.** It is rugged, reliable, economical, contains advanced features, and provides long term duty ratings.

The ALT-120 is designed to provide continuously adjustable AC output up to 120 kV with a full kVA tap at 60 kV. It is rated for 7 kVA of power, enabling it to meet all testing requirements. Its generous duty rating allows the user to perform many tests sequentially or use the unit for other, extended time testing applications. **Since versatility of test equipment is important, the duty cycle of any product should be strongly considered.**

Advantages

The **ALT-120/60** has many advantages over other bucket truck testers.

- 7 kVA of output power
- 120 volt, 30 amp input power consumption
- 1 hr. @ 7kVA and continuous duty @ 4kVA
- 250 μ A current meter range
- Transit protecting meter circuits

Other models available:

ALT-200(F)

0 – 200 kVac @ 30mA, 7 kVA
Optional 50 kVac full kVA
tap available

ALT -300F

0 – 300 kVac @ 23 mA, 7 kVA

Liner Testers available. Up to
50 kVac @ 10 kVA
Refer to HPA Series AC Hipots

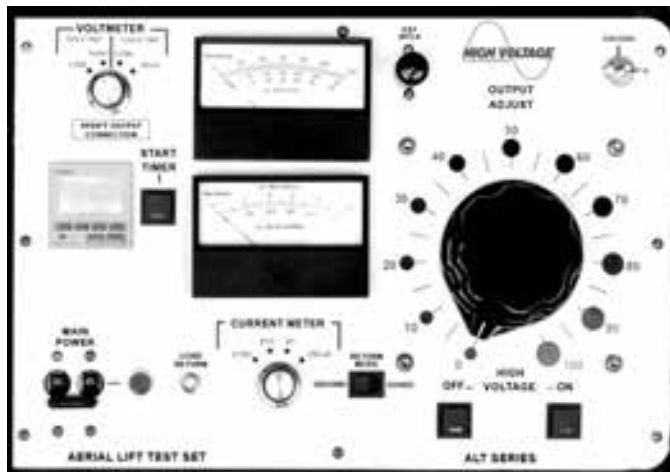

Control Layout

Technical Data	
Input	120 V, 60 Hz, 30 A, or 230 V, 50/60 Hz, 15 A
Output	0-120 kVac / 0-60 kVac
Load Rating	7 kVA Capacitive (1.3 nF @ 120 kV, 5.3 nF @ 60 kV)
Duty Cycle	7 kVA for 1 hour on / 2 hours off, 4 kVA continuous
Output Termination	Top toroid for 120 kV, side tap for 60 kV (no output cable provided)
Distortion	<5%
Meter Accuracy	± 2% of full scale, analog
Voltmeter	3.5" scaled 0-30/60kV and 0-60/120kV AC RMS
Currentmeter	3.5" 0-250 µa and 0-1.0 mA with multipliers: x1, x10, x100 up to 100 mA
Control Dimensions	21" w x 11.25" d x 15.25" h 534 mm w x 286 mm d x 387 mm h
Tank Dimensions	15.5" w x 15.5" d, 27.5" h 394 mm w x 394 mm d, 699 mm h
Weight	Controller: 46 lbs (21 kg), Tank: 160 lbs (73 kg)

Note: For 230 volt line input, an F is suffixed to the model number.

Additional Features

- Guard/Ground Return for isolating ground currents to measure leakage current or total current
- Zero start high voltage safety interlock
- External safety interlock provision
- Cable storage area
- Internal kilovolt meter divider resistors (no external wand)
- Test timer circuit
- Ruggedized meters with glass windows that eliminate static build-up

Our Company and Our Products

High Voltage, Inc. manufactures the most advanced test equipment available for high voltage proof and preventive maintenance testing of electrical apparatus. All of our products are newly designed to meet the present day needs of utilities, industrials, and testing services. Our products offer features and specifications not found elsewhere. Our products include unique, sine-wave output **Very Low Frequency (VLF) AC Hipots, DC Insulation/HV Megohmmeter Test Sets, Aerial Lift Testers, AC Hipots, Cable Thumpers & Radars and AC Oil Dielectric Testers.**



PTS-75 Model
(0-75 kVdc, 10mA)



PTS-130 Model
(0-130 kVdc, 10mA)



PTS-200 Model
(0-200 kVdc, 5mA)

DC Hipot Megohmmeter

Combination Units

Two HV Portable DC Test Sets for the Price of One!

Description

The **PTS Portable DC Test Set Series** of CE marked products are combination high voltage DC proof testers and HV Megohmmeters. Testing for dielectric strength and insulation resistance is now served with one instrument, saving money, size and weight. The PTS series is designed and constructed with field use in mind. It is rugged, reliable and contains all of the features needed for electrical maintenance testing of new or installed electrical apparatus.

Three one piece construction models are available: 37.5 kV, 75 kV and 80kV rated up to 10 mA. Our 100 kV, 130 kV and 200 kV models are designed with separate controls and HV tank. They are fully adjustable and may be used to their full rating for either Hipot or Megohmmeter applications. The PTS series contains numerous features that make it the best Hipot/ Megohmmeter available.

Advantages

Like all High Voltage, Inc. equipment, the PTS series is newly designed, incorporating the latest advances in high voltage technology. No other instrument offers the features, quality and reliability offered here. Several of the many unique advantages include:

- Five range current meter with a 0-1.0 μ A low range for Leakage Current measurements with resolution to 10 nanoamperes
- Megohm readings at any output voltage
- Regulated input for accurate, reliable results. Ideal for field generator use. $\pm 1\%$ stability with $\pm 10\%$ line change (PTS-37.5 & PTS-75 models)
- Internal HV shorting solenoid with discharge resistor
- Continuous Duty Cycle
- Automatic transit protected meters
- Rugged case with cushion grip handles
- Glass front meters eliminate static buildup

Applications

The **PTS Series** can be used as a high voltage DC Proof/Hipot tester or as a high voltage Megohmmeter. It is used to proof test or megohm cable insulation, switchgear, motors, transformers, insulators, generators and other electrical apparatus. Its combination Hipot/HV Megohmmeter capability makes it extremely versatile, especially for field testing applications.



DC Hipot/Megohmmeter

Combination Units

Features

The following are some of the more outstanding features of the PTS Series:

- Two range voltmeter and five range current meter with a 0-1.0 μ A low range with resolution to 10 nanoamperes
- Output current limited to 10 mA, 5 mA on PTS-200
- Internal HV shunting solenoid with discharge resistor (PTS-37.5 through PTS-130)
- Internal discharge/bleed down resistors on PTS-200
- Automatic transit protected meters
- Insulated Return and Guard circuit to bypass stray and unwanted leakage current
- Rugged case with storage for all input/output leads and ground stick (PTS-37.5 through PTS-80)
- Cable storage bin on HV tank (PTS-100 through PTS-200)
- Surge and transient protection
- External safety and zero start interlocks
- Glass front meters eliminate static buildup



Control Layout

		PTS Model Specifications					
		PTS-37.5	PTS-75	PTS-80	PTS-100	PTS-130	PTS-200*
Input	60 Hz 50/60 Hz	120 V, 5 Amps 230 V, 3 Amps	120 V, 10 Amps 230 V, 5 Amps	120 V, 10 Amps 230 V, 5 Amps	120 V, 10 Amps 230 V, 5 Amps	120 V, 15 Amps 230 V, 8 Amps	120 V, 15 Amps 230 V, 8 Amps
Output		0-37.5 kVdc, 10 mA	0-75 kVdc, 10 mA	0-80 kVdc, 10 mA	0-100 kVdc, 10 mA	0-130 kVdc, 10 mA	0-200 kVdc, 5 mA
Polarity		Negative output. Positive ground.					
Duty		Continuous, capacitive charging.					
Ripple		N/A capacitive load Less than 2.5% RMS resistive load					
Regulation		<1% with 10% input line change capacitive load		N/A (no ferro-resonant regulator)			
Kilovoltmeter		0-15/37.5 kVdc	0-37.5/75 kVdc	0-40/80 kVdc	0-50/100 kVdc	0-75/150 kVdc	0-80/200 kVdc
Current Meter (Megohm Scale)		0-1.0 dc microamperes, w/ x1, x10, x100, x1k, x10k 100-1 Megohms, w/ x0.1, x1, x10, x100, x1k					
Control Dimensions		14w x 11d x 14h 356 mmw x 279 mmd x 356 mmh	14w x 11d x 18h 356 mmw x 279 mmd x 457 mmh	14w x 11d x 18h 356 mmw x 279 mmd x 457 mmh	14w x 11d x 14h 356 mmw x 279 mmd x 356 mmh	14w x 11d x 14h 356 mmw x 279 mmd x 356 mmh	14w x 11d x 14h 356 mmw x 279 mmd x 356 mmh
H.V. Tank Dimensions		Included in Control	Included in Control	Included in Control	9.5w x 11.75d x 14.5h 241 mmw x 298 mmd x 368 mmh	12.5w x 12d x 18h 318 mmw x 305 mmd x 457 mmh	13w x 14.5d x 30.5h 330 mmw x 368 mmd x 775 mmh
Control Weight		50 lbs. (23kg)	68 lbs. (31kg)	62 lbs. (28kg)	30 lbs. (14kg)	34 lbs. (15kg)	34 lbs. (15kg)
Tank Weight (With Cable)					68 lbs. (31kg)	82 lbs. (37kg)	150 lbs. (68kg)
Output Termination		Shielded output cable with clip and boot, 20 ft. (6m)					
Additional Cables and Accessories		Input line cord, 10 ft. (3m) Return lead with clip and boot, 20 ft. (6m) Ground lead with clip and boot, 20 ft. (6m) Ground stick with 20 ft. (6m) lead and clip					

Note: For 230 volt line input, an F is suffixed to the model number.
300 kV DC, 5mA and 600 kV DC, 5 mA models available. Please consult the sales dept.

*EPR flexible high voltage x-ray cable is used for the output.

DC Hipot Megohmmeter Test Set

Model PTS-300(F)

Description

The High Voltage, Inc. PTS-300(F) 300kVdc @ 5 mA high voltage test set is designed as a two piece system with a small, portable controller (a bench top version is available) and a single piece high voltage section housed in a fiberglass cylinder with a spinning output. Like all HVI products, the PTS-300 is designed to be rugged and reliable. HVI produces DC hipots from 37.5 kV to 600 kV, as well as many other types of HV test sets.

Specifications

Output:	0 – 300 kVdc @ 5 mA, negative polarity
Duty Cycle:	Continuous
Ripple:	< 2.5% rms w/resistive load
Input:	120V, 15A, 50/60 Hz (F version: 230V, 8A, 50/60 Hz)
Size/weight:	Controller: 14" w x 11" d x 14" h, 34 lbs 356 x 279 x 356 mm, 15 kg
	HV Section: 36" X base with 15" diameter cylinder x 43.5" h, 380 lbs 914 X base with 381 mm diameter cylinder x 1105 mm h, 172 kg

Features

HV Metering: 0 – 120/300 kVdc, 3.5"/90 mm analog meters
Current Metering: 0 – 1.0 uAdc with x1, x10, x100, x10k, x10k multiplier ranges, 3.5"/90 mm analog
Megohmmeter: 0 – 300 kVdc: 100-1 Megohms with x.1, x1, x10, x100, x1k, x10k multipliers
Main Power & HV ON/OFF controls with zero start interlock, Manual Output Voltage control
Fixed overload @ 110% of max current rating, Guard /Ground circuit
Glass front anti-static meters. Durable 100 uA meter movement and transit protected



Oil Dielectric Test Sets

0–60 kVac and 0–100 kVac



DTS-60D

Description

The **DTS Series** of Oil/Liquid Dielectric AC test sets provide repeatable and accurate measurement of the breakdown voltage of insulating fluids used in transformers, circuit breakers, bushings, capacitors, etc. It is rugged, reliable, and designed with field use in mind.

Features

- Three motorized rates of rise: 500V/2000V/3000V per second
- Rate of rise selector switch
- Arc detection with automatic shutdown
- Zero Start safety and test chamber interlock provision
- One-piece portable design
- Window panel for test observation
- Failure indicator
- Accessory outlet located within test chamber
- Simple controls



DTS-100D

Test Cells

High Voltage, Inc. offers 60kV and 100kV test cells capable of testing to ASTM D877 and D1816 and IEC 156 standards.

Oil Tester		Applicable Testing Standard
DTS-60D	DTS-100D	
TCD-3	TCD-N3	ASTM D877
TCD-5	TCD-N5	ASTM D1816
TCD-I2	TCD-NI2	IEC 156

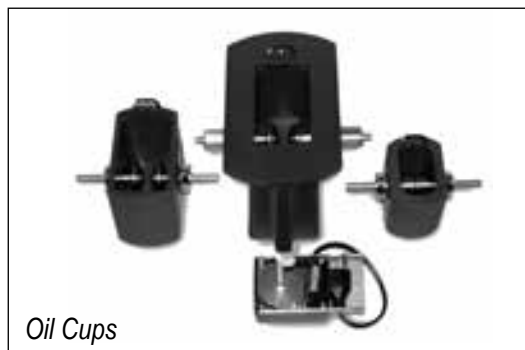

Oil Cups

Oil Dielectric Test Sets

Technical Data		
	DTS-60D	DTS-100D
Input	120V, 60Hz, 7 Amps or 230V, 50/60Hz, 4 Amps	120V, 60Hz, 7 Amps or 230V, 50/60Hz, 4 Amps
Output	0 – 60 kVac, 800 VA Resistive Load	0 – 100 kVac, 800 VA Resistive Load
Output Termination	Dual capacitively graded bushings with cradle contact mounting in test chamber	Dual high voltage sections with brass corona spheres mounting in test chamber
Testing Standards	ASTM D877, ASTM D1816, IEC 156	ASTM D877, ASTM D1816, IEC 156
Gap Gauges Available	0.04" / 0.08" / 0.10" ± 0.0002" 1 mm / 2 mm / 2.5 mm ± 0.005 mm	0.04" / 0.08" / 0.10" ± 0.0002" 1 mm / 2 mm / 2.5 mm ± 0.005 mm
Operating Temperature	-14°F to 104°F -10°C to 40°C	-14°F to 104°F -10°C to 40°C
Distortion	<5%	<5%
Kilovolt Meter and Accuracy	3.5 Digit LED, Scaled 0 – 60 kVac RMS 2% of full scale	3.5 Digit LED, Scaled 0 – 100 kVac RMS 2% of full scale
Dimensions and Weight	15" w x 14" d x 11.5" h, 65 lbs. 381 mm w x 356 mm d x 292 mm h, 29 kg	18.5" w x 16.5" d x 16.5" h, 100 lbs. 470 mm w x 419 mm d x 419 mm h, 45 kg

NOTE: For 230 Volt line input models, an F is suffixed to the model number.



DTS-60D Front Panel



DTS-100D Front Panel

Our Company and Our Products

High Voltage, Inc. manufactures the most advanced test equipment available for high voltage proof and preventive maintenance testing of electrical apparatus. All of our products are newly designed to meet the present day needs of utilities, industrials, and testing services. Our products offer features and specifications not found elsewhere. Our products include unique, sine-wave output **Very Low Frequency (VLF) AC Hipots, DC Insulation/HV Megohmmeter Test Sets, Aerial Lift Testers, AC Hipots, Cable Thumpers & Radars and AC Oil Dielectric Testers.**

Automatic Oil Dielectric Tester

Model No. DTS-60A(F)

The **DTS-60A** is a fully automatic liquid dielectric test set, typically used for testing the voltage breakdown level of insulating oils. The most commonly used testing standards are preprogrammed into the controls. Just hit the start button and the test is performed. Custom test sequences can also be programmed. The results are stored internally for downloading to a computer and/or for printing on the printer included.



Features

- Clear and easy to use controls
- 128 x 64 dot matrix crystal display
- 10 preprogrammed standard test sequences
ASTM D877/87, ASTM D 1816/97, IEC 156/63, IEC 156/95, VDE 0370-P5/92, CEI 10-1/73, IRAM 2341/72, UTE C27-221/74, RVHP 1985, PN-77/ED4408
- Internal memory holds last 50 tests w/ RS232 interface
- User definable test sequences
- Ambient temperature sensor
- English, German, Spanish, French, Greek
- Thermal printer included

Specifications

Input:	120 V, 50/60 Hz, 7 amps (F) 230 V, 50/60Hz, 3 amps
Output:	0 – 60 kVac, 800 VA resistive
Voltage Rise:	Variable. 0 – 5 kV/s in .1 kV/s steps
Shutdown time:	4.2 ms
Voltage Accuracy:	0.5%
Size:	15" w x 14" d x 11.5" h, 65 lbs 381 mm x 356 mm x 292 mm, 29 kg
Operating temp:	-14° F to 113° F, -10° C to 45° C



Oil Cups

60 kV & 100 kV manually operated Oil Dielectric Testers also available

High Voltage, Inc. designs and manufactures high voltage test equipment for utility and industrial applications. Also available are two other Oil Dielectric Tester models, Very Low Frequency (VLF) AC test sets, AC and DC hipots, Aerial Lift testers, Cable Fault Locators, and other products.

High Voltage AC/DC Precision Dividers

DVR-150 & DVR-300

0-150 kV & 0-300 kV AC & DC Voltage



DVR-150



DVR-300

Description

The **DVR-150** and the **DVR-300** are precision resistor/capacitor high voltage dividers that provide low voltage outputs proportional to the applied high voltage input. Their 1000:1 & 10,000:1 ratios, respectively, extend the measurement capability of most digital voltmeters and oscilloscopes to 150,000 volts or 300,000 volts. The divider includes a switchable low end impedance to match various metering inputs.

Both are suited for waveshape/harmonic analysis using a standard oscilloscope and can be used to measure DC multiplier circuits or AC transformers, limited only by the Digital Volt Meter (DVM) connected as the metering device. They are not designed for impulse or square wave applications.

Features

- Can be used as a reference for in-house high voltage calibrations
- Designed to be used with most DMMs or oscilloscopes
- No external power sources required
- Switch selectable 10 Meg or 1 Meg low end impedance
- Light weight, transit sturdy assembly
- Less susceptible to effects of electric field proximity



Control Layout

Specifications

Voltage Range	1 - 150 kV or 1 - 300 kV DC or AC to 1 kHz sinusoidal
Output	DVR-150: 1.0 Volt per 1 kV applied DVR-300: 0.1 Volt per 1 kV applied
Accuracy & Temp Ratings	± 0.5%, 50° to 104°F, 10° to 40°C
Input Resistance	DVR-150: 715 MΩ DVR-300: 1430 MΩ
Input Capacitance	DVR-150: 96.3 pF, DVR-300: 49 pF
Cables Provided	25 ft. (7.6M) RG58/U coaxial & Ground lead
Divider Termination	DVR-150: 13" (330mm) diameter spinning DVR-300: 24" (559 mm) diameter spinning
Size & Weight	DVR-150: 13" w x 13" d x 24.5" h, 20 lbs. 330 mm w x 330 mm d x 622 mm h, 9 kg DVR-300: 24" w x 24" d x 61" h, 85 lbs. 610 mm w x 610 mm d x 1550 mm h, 39 kg



HVI: The World's VLF Source
All HVI Products are **Made in the USA**

Ω -CHECK™

CONCENTRIC NEUTRAL TESTER

The Best Method of Measuring Concentric Neutral Integrity vital to maintaining system stability, reliability, and safety

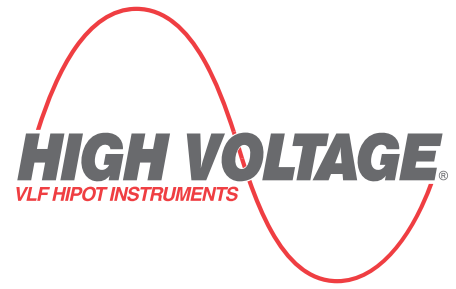

Easy to use

Simple operating procedure
Few controls and settings to learn
No programming – data entry only
Tests take <10 seconds once setup

Easy to set up

Cables Remain Energized
Neutral remains connected
Light weight and portable
Cable reels make setup easy



Field proven for >15 years

Rugged & Reliable
Simple to service
Water Resistant
Used by many utilities

Results instant & clear

% of neutral remaining
Resistance of neutral
Power factor of neutral
Volts & amps on neutral

Designed specifically for testing energized cables, the Ω -CHECK™ Concentric Neutral Tester accurately measures how many strands of a concentric neutral remain intact

Safety and Operational Benefits of Healthy Neutrals – Many Good Reasons to Test

- Ω **Help prevent shock hazard conditions** and locate stray voltages and currents
- Ω **Help overload protection systems function** as expected during cable faults. Limit possible damage.
- Ω **AC Withstand and diagnostic testing** results, with VLF or 50/60 Hz, can be compromised if no neutral
- Ω **Injecting/Rejuvenating cables?** Make sure enough neutral remains to justify the effort and expense
- Ω **Prioritize cable replacement** efforts by comparing the neutral condition of many cables and replace only the bad ones, not those with acceptable neutrals
- Ω **Fault locating cables:** avoid lost time, minimal success, and unsafe conditions if little neutral remains. Don't thump cables with open neutrals, never to find the fault and sending kjoules of energy into the earth

The Ω -CHECK™ Difference: AC voltage (not DC) is applied, polarity reversing for neutral load current compensation is performed, voltage drop measurements are taken at the neutral ends, and the test results are compared to the data entered of the actual cable under test, making the Ω -CHECK™ tester the most accurate method of measuring concentric neutral integrity. It is economical, easy to operate and interpret, very portable, rugged, reliable, and easily serviced.

What is a Concentric Neutral?

Like the pictures below show, a “Concentric” Neutral is a ground shield designed with many individual strands of wire that are wrapped around the outside of a cables insulation layer. They are helically wrapped to twist around the insulation along the length of the cable. The primary purpose for the neutral is to provide a uniform ground shield around the cable to equalize and minimize voltage stress on the cable and to provide a low impedance path for the distribution systems Return and Fault currents. The many purposes of the neutral are described below. There are other neutral designs that use a continuous **foil wrap** or a **tape shield** with many overlapping strips of copper or aluminum. The Ω -CHECK™ tester is designed to test cables with concentric neutrals.



The Vital Functions of a Concentric Neutral:

- Creates a uniform ground plane around the cable to insure equal voltage stress
- Provides a path for Return current if circuit design requires it be used for that
- Provides a safe path for short circuit currents, instead of nearby gas or water pipes
- Maintains system voltage stability and uniform voltage drop along a cable
- Helps prevent high fault currents from reaching a conductor of an adjacent cable
- Permits predictable overload relay coordination, preventing possible damage
- Provides safety from dig-ins of live cables by providing a grounded shield cover



What can the Ω -CHECK™ Test?

The Ω -CHECK™ tester is designed to test concentric neutrals that consist of many round or flat wires. It cannot test neutrals that are “foil” or “tape shield” designs. The Ω -CHECK™ tester does not measure the partial corrosion of the wires but measures if they are **open or closed** due to total corrosion or breakage. When a strand opens, there is a very incremental and measurable change in the neutral’s resistance. **This is what the Ω -CHECK™ tester measures; how many strands remain continuous.**

The Ω -CHECK™ tester can also be used for other applications, like **substation ground cable integrity testing per IEEE Std 81-**

Theory of Operation

The Ω -CHECK™ tester is designed to measure how many strands remain of a concentric neutral. The instrument consists of a variable 48 volt AC power supply, a microprocessor based programming, control, and acquisition module, a “clamp-on” current meter, and two 500’ reels of two-conductor test lead for connecting to the Local and Remote ends of the neutral being tested: one wire pair is used to inject the current through the neutral and the other pair is used to measure the voltage across the neutral. The AC power supply injects a current up to 30 amperes into the total ground system. The current probe placed around the neutral tested measures the current flowing only in that neutral. The diagram here shows how the system works.

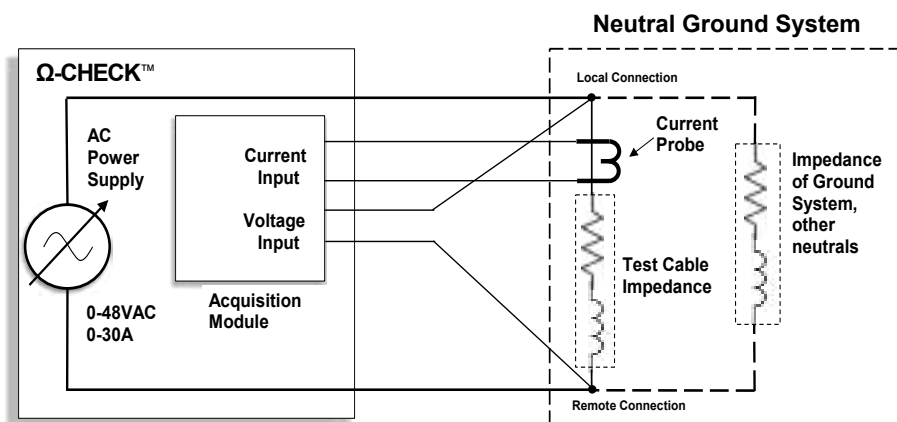

The acquisition module receives the voltage across and the current through the tested neutral, from which the resistance and power factor are computed. Relays are used to swap the test current between polarities to help compensate for neutral load current effect. From the cable’s neutral data previously entered into the controls, the system computes, compares, and displays the % of the neutral remaining, and other valuable data.

Method of Operation

The Ω -CHECK™ compares the resistance of the neutral tested to a perfect neutral of the same specifications. To do this, the operator first enters the cable's neutral data into the controls. The accuracy of the test results are as good as the accuracy of the data entered.

Data entered: ① Cable length ② # of neutral strands ③ AWG size of strands ④ Test ID #

The microprocessor computes the ideal resistance of a neutral of that specification and then compares it to the test data gathered. The condition of the tested neutral is displayed along with several other important test results.

Test Connections

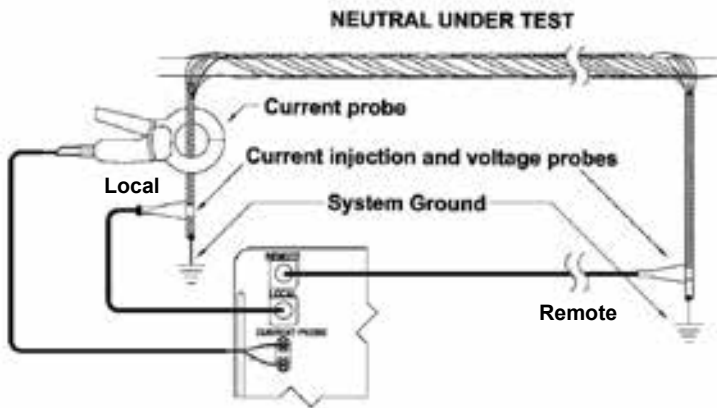

Setup & Test Procedure

A two wire cable connection is made from the controller to the **Local & Remote** ends of the cable

One set of wires injects the AC current through the neutral while the others measure the AC voltage drop across the neutral

The clamp-on current meter is placed around the neutral tested

The operator inputs the neutral's data into the controls

Starting the test, an AC voltage up to 48 volts pushes a current up to 30 amps into the entire neutral ground system

The voltage across and only the current thru the target neutral is measured, not the total current pushed thru all grounds

While the polarity of the voltage & current are swapped several times, the neutral's resistance is computed

When test numbers stabilize, press HOLD to freeze the results

After the test is run, the Ω -CHECK™ tester provides the following information:

The % of the original neutral remaining
The resistance of the neutral in $\Omega/100'$
The power factor of the neutral

The resistance ratio compared to a new neutral
The voltage and current of the tested neutral
The option to download test results to SD chip

Cable Connection Application Note

There are two methods of connecting the remote, or far, end of the cable neutral to the Ω -CHECK™ controls. Usually the two cable reels provided are used, however there are circumstances where this may not be the best method.

① Two 500' cable reels are provided – one is continuous and the other has connector breaks every 100'

The Ω -CHECK™ tester must connect to both ends of the neutral tested. The **Local** connection is made to the neutral near the instrument and the **Remote** is made at the far end, possibly 500' – 1000' away. The cables provided are light but rugged enough to be easily dragged to the far end and rewound after. If this method of Remote connection is not practical, or more than 1000' away and you don't have an additional reel, there is an alternative. (Using the cable reels, the maximum test cable length can be 1500' - 2000'.)

② Use the test cable's conductor or a parallel conductor, if de-energized, as the Remote connection lead

If the cable tested, or a parallel cable, is de-energized, its conductor can be used as the Remote connection to the instrument. Connect the Remote lead from the front panel to the open conductor at the near end. The far end of that conductor must also be open and be connected to the neutral of the cable tested. The test is then carried out as normal, however, the resistance of the conductor must be known and subtracted from the resistance of the neutral being tested. This operation is simple to understand, perform, and calculate the resistance of the tested neutral to determine how it compares to a perfect neutral.

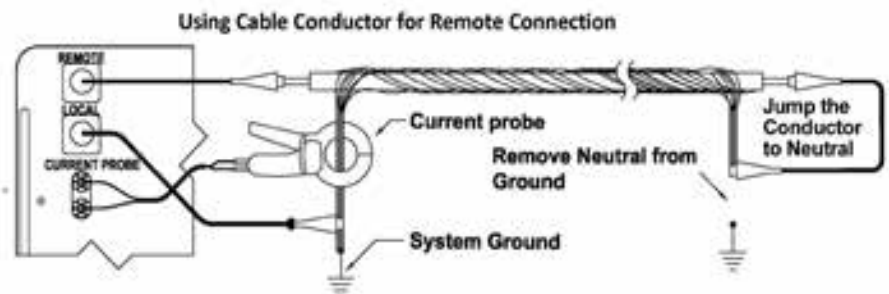

Sample Screen Shots

```

Ω-CHECK model 30 2.0
HIGH VOLTAGE, INC
+1.518.329.3275
WWW.HVINC.COM

SET POWER SUPPLY
OUTPUT TO 30 AMPS

THEN PRESS ENTER

10#14 L: 260 TN:1234
U: 2.67 R/L:0.033
I:19.01 RATIO: 1.19
PF:0.61 PCT NEW: 84
    
```

Ω-CHECK™ Control Panel



Test Data Export from SD Card

TEST	TIME	DATE	NEUTRAL	LENGTH	VOLTS	AMPS	PF	R/L	RES	PCT
8	13:22	03/26/13	20 #14	375	18.25	30.70	0.22	0.035	0.130	40
1	14:27	07/15/13	16 #12	468	5.27	28.90	0.40	0.016	0.073	70
2	14:30	07/15/13	16 #12	468	1.89	10.33	0.40	0.016	0.074	69

Data Output: The Ω-CHECK™ tester uses an SD Card to capture the test data. The saved data can be downloaded to a spreadsheet for manipulation and reporting.

Ω-CHECK™ Package

- Controls/Power Supply
- Cable Reels A & B, each 500'
- Clamp-on Current Meter, 200A
- Clamps for cable connections, 2 pcs
- Cable to clamp-on meter, 10'
- Cables between reels & neutral, 10'
- Line cord 10' & #2 Ground Cable, 20'
- SD memory card & Operators manual



Model OCK-30 Specifications

Electrical:	
Input power:	1800 VA, 120 V @ 60Hz, 15 A max.
Output power:	0-48 VAC, 30 A max.
Instrumentation	
Current probe:	Output: 1000:1
V & I meters:	Accuracy: ±2%
V & I measured:	Accuracy: ±1%
Phase angle – P.F.	±1.5°
Environmental	
Temperature Operating:	0 to 45°C, 0 to 113°F
Storage:	-20° to 70°C, -5° to 158°F
Humidity:	85% noncondensing
Dimensions & Weight	
Control box:	20" w x 12" d x 19" h, 55 lbs
Cable reels (ea.):	12" w x 11.5" d x 14.75" h, 23 lbs
Cables & Accessories	Supplied in canvas HVI bag

Cable Testing & Other Products from High Voltage, Inc.

HVI is the world's source for VLF technology. HVI is a world leader in the design and production of high voltage equipment for testing utility, industrial, and commercial applications for most types of substation apparatus, aerial lifts, motors and generators, MV & HV cable, and cable fault locating products. One of our specialties is test equipment for performing **AC Withstand and AC Diagnostic testing** of medium and high voltage cables. We also offer **Tan Delta and Partial Discharge** cable testing diagnostic equipment to operate with our VLF or 50/60 Hz AC power supplies. A quick summary follows:

Very Low Frequency (VLF) AC Hipots: 28 kV – 200 kV, sine wave producing, .4 uF – 50 uF load rating, 0.1 Hz – 0.01 Hz.

Tan Delta & Partial Discharge: HVI designed TD products and PD from others for diagnostic testing cables rated up to 230 kVac

Cable Fault Locating: Standard Thumpers up to 9/18/36 kV @ 3200 joules – custom to 100 kV @ 7500 joules. VLF/Thumper combo, & TDR available

AC Dielectric testers up to 50 kVA, Field Portable AC hipots, DC Voltage Hipots to 600 kV, Oil Testers, Bucket Truck Boom and Liner AC & DC Hipots, HV Dividers, and more.

Ω-CHECK is a trademark of High Voltage, Inc.



HIGH VOLTAGE, INC.
31 County Rt. 7A • Copake, NY 12516
Phone: (518) 329-3275
Fax: (518) 329-3271
E-Mail: sales@hvinc.com

©COPYRIGHT 2015 - HIGH VOLTAGE, INC.

HIGH VOLTAGE, INC. - Manufacturers of high voltage test equipment. Products include portable VLF AC .1Hz to .01Hz. Very Low Frequency, sinewave output hipots up to 200 kV; Tan delta and PD diagnostic measurement bridges for cable diagnostics, portable switchgear and bottle testers up to 100 kV AC ; Portable DC Hipots/Megohmmeters to 300 kV DC ; Oil Test sets at 60 kV or 100 kV ; Aerial lift and bucket truck testers to 300 kV AC; High Power AC Dielectric test sets up to 300 kV AC @ 40 KVA ; OHM Check concentric neutral tester ; Controlled energy cable fault locators, Radar and Tracing devices ; 150 kV and 300 kV HV voltage dividers.